



E50B1, E50C2, E50C3

Compact Power and Energy Meter

Product Overview

The E50 DIN Rail Power Meter provides a solution for measuring energy data with a single device. Inputs include Control Power, CT, and 3-phase voltage. The E50 supports multiple output options, including solid state relay contacts, Modbus (with or without data logging), and pulse. The LCD screen on the faceplate allows instant output viewing.

The meter is housed in a plastic enclosure suitable for installation on T35 DIN rail according to EN50022. The E50 can be mounted with any orientation over the entire ambient temperature range, either on a DIN rail or in a panel. The meter is not sensitive to CT orientation to reduce installation errors.

Product Identification

Model	Description	Output			Data Logging
		Pulse	RS-485	Alarm	
E50B1	Pulse Output Only	• (2 pulses)			
E50C2	Modbus output, full data set	•	•	•	
E50C3	Modbus output, data logging	•	•	•	•

Specifications

MEASUREMENT ACCURACY	
Real Power and Energy	IEC 62053-22 Class 0.2S, ANSI C12.20 0.2%
Reactive Power and Energy	IEC 62053-23 Class 2, 2%
Current	0.4% (+0.015% per °C deviation from 25°C) from 5% to 100% of range; 0.8% (+0.015% per °C deviation from 25°C) from 1% to 5% of range
Voltage	0.4% (+0.015% per °C deviation from 25°C) from 90V _{L-N} to 600VAC _{L-L}
Sample Rate	2520 samples per second
Data Update Rate	1 sec
Type of Measurement	True RMS up to the 21st harmonic 60 Hz; One to three phase AC system
INPUT VOLTAGE CHARACTERISTICS	
Measured AC Voltage	Minimum 90V _{L-N} (156V _{L-L}) for stated accuracy; UL Maximum: 600V _{L-L} (347V _{L-N}) CE Maximum: 300V _{L-N}
Metering Over-Range	+20%
Impedance	2.5 MΩ _{L-N} / 5 MΩ _{L-L}
Frequency Range	45 to 65 Hz
INPUT CURRENT CHARACTERISTICS	
CT Scaling	Primary: Adjustable from 5 A to 32,000 A
Measurement Input Range	0 to 0.333 VAC or 0 to 1.0 VAC (+20% over-range), rated for use with Class 1 voltage inputs
Impedance	10.6 kΩ (1/3 V mode) or 32.1 kΩ (1 V mode)



⚠️ DANGER

HAZARD OF ELECTRIC SHOCK, EXPLOSION, OR ARC FLASH

- Follow safe electrical work practices. See NFPA 70E in the USA, or applicable local codes.
- This equipment must only be installed and serviced by qualified electrical personnel.
- Read, understand and follow the instructions before installing this product.
- Turn off all power supplying equipment before working on or inside the equipment.
- Product may use multiple voltage/power sources. Disconnect all sources of power before servicing.
- Use a properly rated voltage sensing device to confirm power is off.

DO NOT DEPEND ON THIS PRODUCT FOR VOLTAGE INDICATION.

- Current transformer secondaries must be shorted or connected to a burden at all times.
- Products rated only for basic insulation must be installed on insulated conductors.
- Replace all doors, covers and protective devices before powering the equipment.

Failure to follow these instructions will result in death or serious injury.

A qualified person is one who has skills and knowledge related to the construction and operation of this electrical equipment and installations, and has received safety training to recognize and avoid the hazards involved. NEC2014 Article 100 No responsibility is assumed by Veris Industries for any consequences arising out of the use of this material.

Control system design must consider the potential failure modes of control paths and, for certain critical control functions, provide a means to achieve a safe state during and after a path failure. Examples of critical control functions are emergency stop and over-travel stop.

⚠️ WARNING

LOSS OF CONTROL

- Assure that the system will reach a safe state during and after a control path failure.
- Separate or redundant control paths must be provided for critical control functions.
- Test the effect of transmission delays or failures of communication links.¹
- Each implementation of equipment using communication links must be individually and thoroughly tested for proper operation before placing it in service.

Failure to follow these instructions may cause injury, death or equipment damage.

¹For additional information about anticipated transmission delays or failures of the link, refer to NEMA ICS 1.1 (latest edition), *Safety Guidelines for the Application, Installation, and Maintenance of Solid-State Control* or its equivalent in your specific country, language, and/or location.

NOTICE

- This product is not intended for life or safety applications.
- Do not install this product in hazardous or classified locations.
- The installer is responsible for conformance to all applicable codes.
- Mount this product inside a suitable fire and electrical enclosure.

FCC PART 15 INFORMATION

NOTE: This equipment has been tested by the manufacturer and found to comply with the limits for a class B digital device, pursuant to part 15 of the FCC Rules. These limits are designed to provide reasonable protection against harmful interference when the equipment is operated in a residential environment. This equipment generates, uses, and can radiate radio frequency energy and, if not installed and used in accordance with the instruction manual, may cause harmful interference to radio communications. This device complies with part 15 of the FCC Rules. Operation is subject to the following two conditions:

- (1) This device may not cause harmful interference, and
- (2) this device must accept any interference received, including interference that may cause undesired operation.

Modifications to this product without the express authorization of the manufacturer nullify this statement.

For use in a Pollution Degree 2 or better environment only. A Pollution Degree 2 environment must control conductive pollution and the possibility of condensation or high humidity. Consider the enclosure, the correct use of ventilation, thermal properties of the equipment, and the relationship with the environment. Installation category: CAT II or CAT III. Provide a disconnect device to disconnect the meter from the supply source. Place this device in close proximity to the equipment and within easy reach of the operator, and mark it as the disconnecting device. The disconnecting device shall meet the relevant requirements of IEC 60947-1 and IEC 60947-3 and shall be suitable for the application. In the US and Canada, disconnecting fuse holders can be used. Provide overcurrent protection and disconnecting device for supply conductors with approved current limiting devices suitable for protecting the wiring. If the equipment is used in a manner not specified by the manufacturer, the protection provided by the device may be impaired.

Specifications (cont.)

CONTROL POWER	
AC	5VA max.; 90V min. UL Maximum: $600V_{L-L}$ ($347V_{L-N}$) CE Maximum: $300V_{L-N}$
DC*	3 W max.; UL and CE: 125 to 300VDC
Ride Through Time	100 msec at 120VAC
OUTPUT	
Alarm Contacts (all models)	N.C., static output (30VAC/DC, 100mA max. @ 25°C, derate 0.56mA per °C above 25°C)
Real Energy Pulse Contacts (all models) AND Reactive Energy Pulse Contacts (E5OB1A only)	N.O., static output (30VAC/DC, 100mA max. @ 25°C, derate 0.56mA per °C above 25°C)
RS-485 Port (E5OCxA)	2-wire, 1200 to 38400 baud, Modbus RTU
MECHANICAL CHARACTERISTICS	
Weight	0.62 lb (0.28 kg)
IP Degree of Protection (IEC 60529)	IP40 front display; IP20 Meter
Display Characteristics	Back-lit blue LCD
Terminal Block Screw Torque	0.37 to 0.44 ft-lb (0.5 to 0.6 N·m)
Terminal Block Wire Size	24 to 14 AWG (0.2 to 2.1 mm ²)
Rail	T35 (35mm) DIN Rail per EN50022
OPERATING CONDITIONS	
Operating Temperature Range	-30° to 70°C (-22° to 158°F)
Storage Temperature Range	-40° to 85°C (-40° to 185°F)
Humidity Range	<95% RH noncondensing
Altitude of Operation	3000 m
COMPLIANCE INFORMATION	
US and Canada	CAT III, Pollution degree 2; for distribution systems up to $347V_{L-N}$ / $600VAC_{L-L}$
CE	CAT III, Pollution degree 2; for distribution systems up to $300V_{L-N}$
Dielectric Withstand	Per UL 508, EN61010
Conducted and Radiated Emissions	FCC part 15 Class B, EN55011/EN61000 Class B (residential and light industrial)
Conducted and Radiated Immunity	EN61000 Class A (heavy industrial)
US and Canada (cULus)	UL508 (open type device)/CSA 22.2 No. 14-05
Europe (CE)	EN61010-1

* External DC current limiting is required, see fuse recommendations.

Table of Contents

Dimensions	4
Data Outputs	4
Product Diagram	5
Display Screen Diagram	5
Installation	6
Supported System Types	7
Wiring Symbols	7
Wiring	8
Control Power	9
Quick Setup Instructions	10
Solid State Output	11
User Interface Menu Abbreviations Defined	11
User Interface for Data Configuration	12
Alert/Reset Information	13
User Interface for Setup	14
RS-485 Communications (E5OC3 Only)	16
Data Logging (E5OC3 Only)	16
Modbus Point Map Overview	17
Standard Modbus Default Settings	17
Modbus Point Map Overview	18
Modbus Point Map	19
Troubleshooting	26
China RoHS Compliance Information (EFUP Table)	26

Dimensions

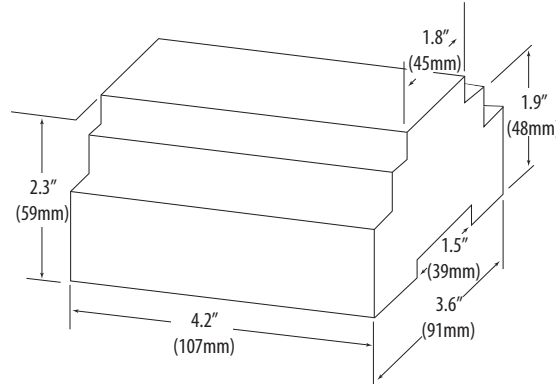

Bottom View (DIN Mount Option)

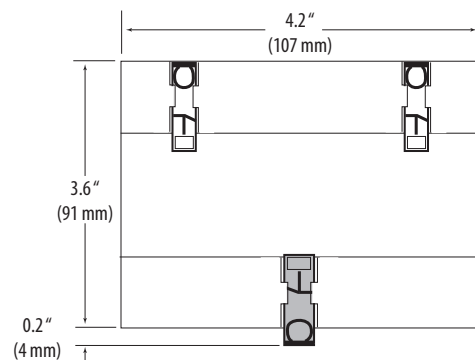

Bottom View (Screw Mount Option)

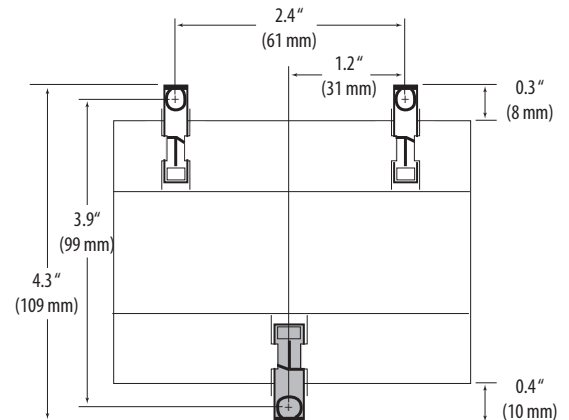

Data Outputs

Full Data Set (FDS):

- Power (kW)
- Energy (kWh)
- Configurable for CT & PT ratios, system type, and passwords
- Diagnostic alerts
- Current: 3-phase average
- Volts: 3-phase average
- Current: by phase
- Volts: by phase Line-Line and Line-Neutral
- Power: Real, Reactive, and Apparent 3-phase total and per phase
- Power Factor: 3-phase average and per phase
- Frequency
- Power Demand: Most Recent and Peak
- Demand Configuration: Fixed, Rolling Block, and External Sync (Modbus only)

Data Logging (includes all FDS outputs, plus):

- Real Time Clock: user configurable
- 10 user configurable log buffers: each buffer holds 5760 16-bit entries
(User configures which 10 data points are stored in these buffers)
- User configurable logging interval
(When configured for a 15 minute interval, each buffer holds 60 days of data)
- Continuous and Single Shot logging modes: user selectable
- Auto write pause: read logs without disabling the meter's data logging mode

Product Diagram

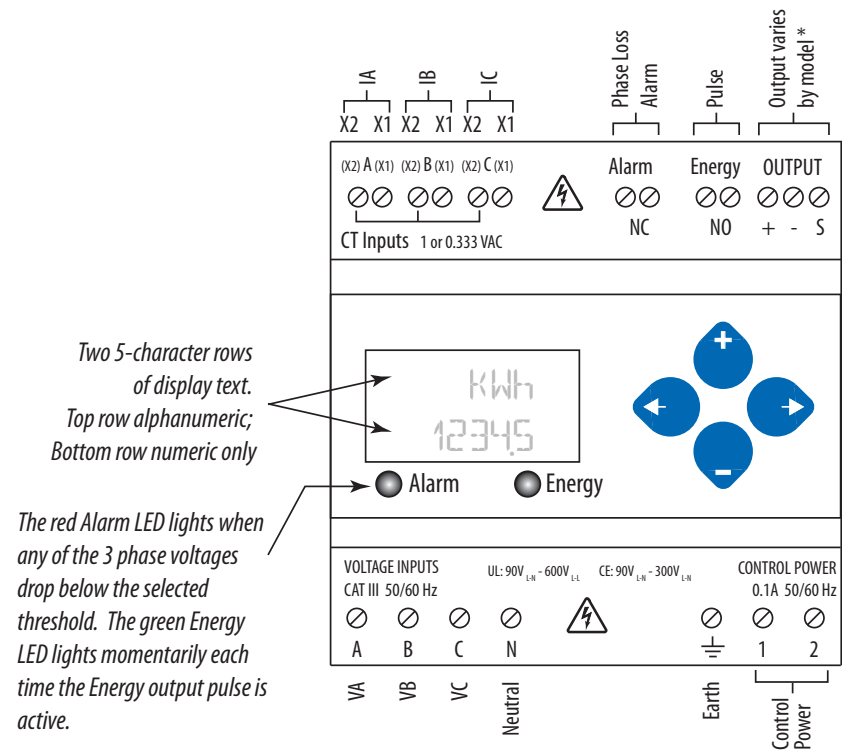

* Two Output Options Available

Pulse (E5OB1)

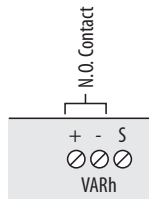

RS-485 (E5OCx)

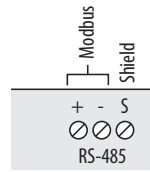

Display Screen Diagram

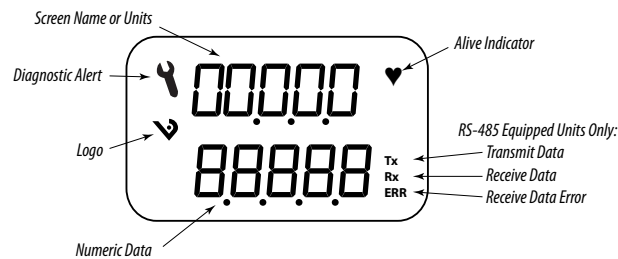

LCD Screen:

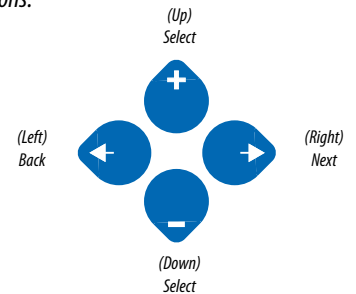

Buttons:



Installation

-  **Disconnect power prior to installation.**
-  **Reinstall any covers that are displaced during the installation before powering the unit.**
-  **Mount the meter in an appropriate electrical enclosure near equipment to be monitored.**

Do not install on the load side of a Variable Frequency Drive (VFD), aka Variable Speed Drive (VSD) or Adjustable Frequency Drive (AFD).

The meter can be mounted in two ways: on standard 35 mm DIN rail or screw-mounted to the interior surface of the enclosure.

A. DIN Rail Mounting

1. Attach the mounting clips to the underside of the housing by sliding them into the slots from the inside. The stopping pegs must face the housing, and the outside edge of the clip must be flush with the outside edge of the housing.
2. Snap the clips onto the DIN rail. See the diagram of the underside of the housing (below).

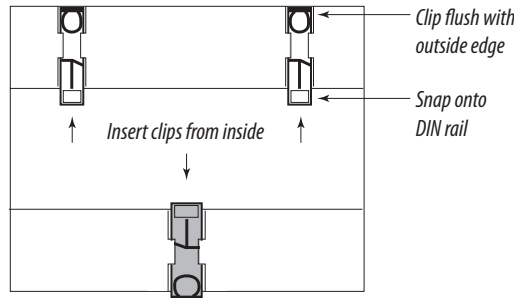

3. To reduce horizontal shifting across the DIN rail, use two Veris AV02 end stop clips.

B. Screw Mounting

1. Attach the mounting clips to the underside of the housing by sliding them into the slots from the outside. The stopping pegs must face the housing, and the screw hole must be exposed on the outside of the housing.
2. Use three #8 screws (not supplied) to mount the meter to the inside of the enclosure. See the diagram of the underside of the housing (below).

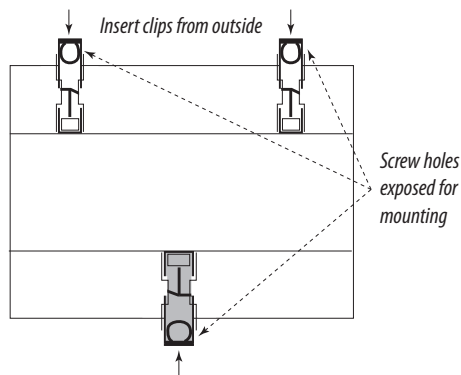

Supported System Types

The meter has a number of different possible system wiring configurations (see Wiring section). To configure the meter, set the System Type via the User Interface or Modbus register 130 (if so equipped). The System Type tells the meter which of its current and voltage inputs are valid, which are to be ignored, and if neutral is connected. Setting the correct System Type prevents unwanted energy accumulation on unused inputs, selects the formula to calculate the Theoretical Maximum System Power, and determines which phase loss algorithm is to be used. The phase loss algorithm is configured as a percent of the Line-to-Line System Voltage (except when in System Type 10) and also calculates the expected Line to Neutral voltages for system types that have Neutral (12 & 40).





Values that are not valid in a particular System Type display as “----” on the User Interface or as QNAN in the Modbus registers.

Number of wires	CTs		Voltage Connections			System Type		Phase Loss Measurements			Wiring Diagram
	Qty	ID	Qty	ID	Type	Modbus Register 130	User Interface: SETUP>S SYS	VLL	VLN	Balance	Diagram number
Single-Phase Wiring											
2	1	A	2	A, N	L-N	10	1L + 1n		AN		1
2	1	A	2	A, B	L-L	11	2L	AB			2
3	2	A, B	3	A, B, N	L-L with N	12	2L + 1n	AB	AN, BN	AN-BN	3
Three-Phase Wiring											
3	3	A, B, C	3	A, B, C	Delta	31	3L	AB, BC, CA		AB-BC-CA	4
4	3	A, B, C	4	A, B, C, N	Grounded Wye	40	3L + 1n	AB, BC, CA	AN, BN, CN	AN-BN-CN & AB-BC-CA	5, 6

Wiring Symbols

To avoid distortion, use parallel wires for control power and voltage inputs.

The following symbols are used in the wiring diagrams on the following pages.

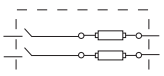
Symbol	Description
	Voltage Disconnect Switch
	Fuse (installer is responsible for ensuring compliance with local requirements. No fuses are included with the meter.)
	Earth ground
	Current Transducer
	Potential Transformer
	Protection containing a voltage disconnect switch with a fuse or disconnect circuit breaker. The protection device must be rated for the available short-circuit current at the connection point.

CAUTION

RISK OF EQUIPMENT DAMAGE

- This product is designed only for use with 1V or 0.33V current transducers (CTs).
- DO NOT USE CURRENT OUTPUT (e.g. 5A) CTs ON THIS PRODUCT.
- Failure to follow these instructions can result in overheating and permanent equipment damage.

Wiring

⚠ WARNING ⚡

RISK OF ELECTRIC SHOCK OR PERMANENT EQUIPMENT DAMAGE
 CT negative terminals are referenced to the meter's neutral and may be at elevated voltages

- Do not contact meter terminals while the unit is connected
- Do not connect or short other circuits to the CT terminals

Failure to follow these instructions may cause injury, death or equipment damage.

Diagram 1: 1-Phase Line-to-Neutral 2-Wire System 1 CT

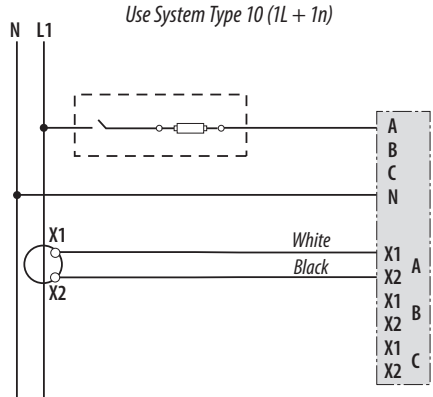

Diagram 2: 1-Phase Line-to-Line 2-Wire System 1 CT

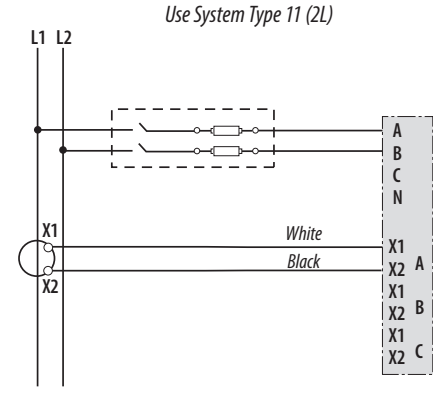

Diagram 3: 1-Phase Direct Voltage Connection 2 CT

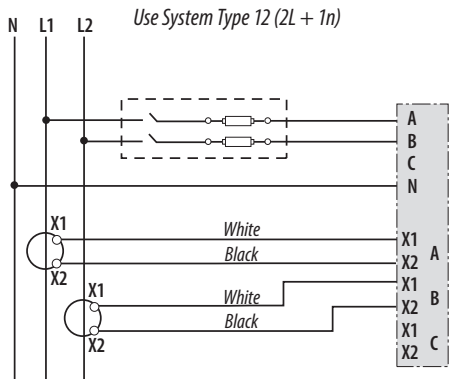

Diagram 4: 3-Phase 3-Wire 3 CT no PT

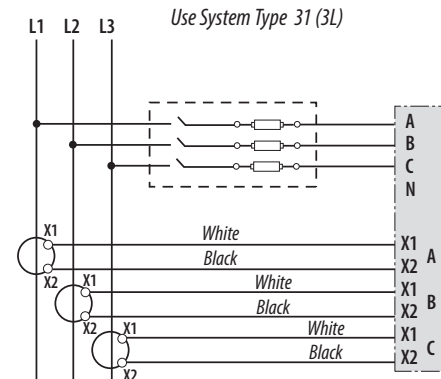

Diagram 5: 3-Phase 4-Wire Wye Direct Voltage Input Connection 3 CT

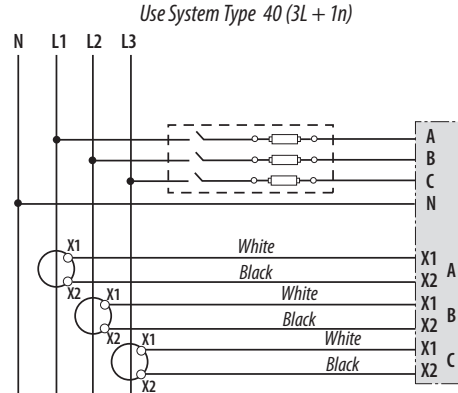
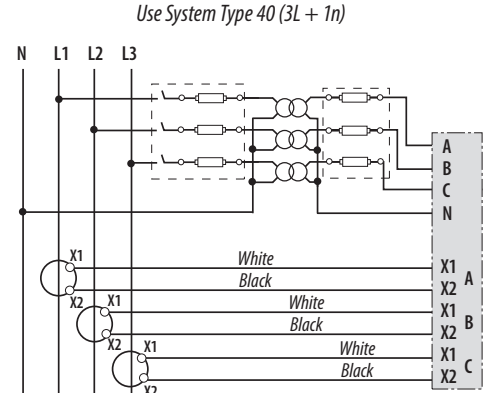
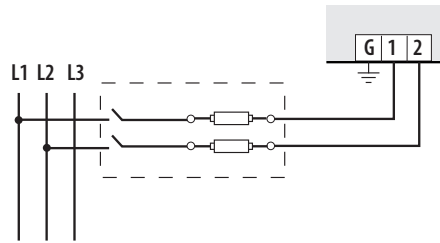

Diagram 6: 3-Phase 4-Wire Wye Connection 3 CT 3 PT



Control Power

Direct Connect Control Power (Line to Line)



Line to Line from 90 VAC to 600 VAC (UL). In UL installations the lines may be floating (such as a delta). If any lines are tied to an earth (such as a corner grounded delta), see the Line to Neutral installation limits. In CE compliant installations, the lines must be neutral (earth) referenced at less than 300 VAC_{L-N}

Direct Connect Control Power (Line to Neutral)

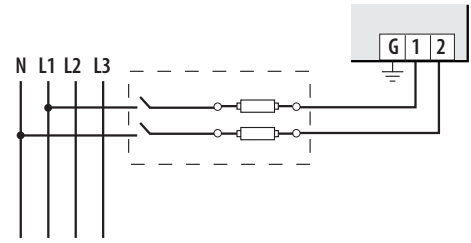

Line to Neutral from 90 VAC to 347 VAC (UL) or 300 VAC (CE)

Direct Connect Control Power (DC Control Power)

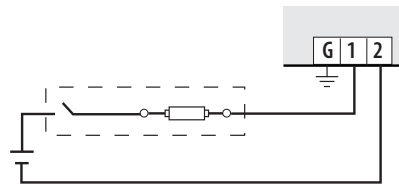

*DC Control Power from 125 VDC to 300 VDC
 (UL and CE max.)*

Control Power Transformer (CPT) Connection

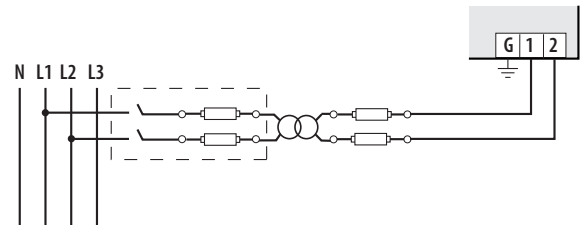

The Control Power Transformer may be wired L-N or L-L. Output to meet meter input requirements

Fuse Recommendations













































Keep the fuses close to the power source (obey local and national code requirements).

For selecting fuses and circuit breakers, use the following criteria:

- Select current interrupt capacity based on the installation category and fault current capability.
- Select over-current protection with a time delay.
- Select a voltage rating sufficient for the input voltage applied.
- Provide overcurrent protection and disconnecting means to protect the wiring. For AC installations, use Veris AH02, AH03, AH04, or equivalent. For DC installations, provide external circuit protection. Suggested: 0.5 A, time delay fuses.
- The earth connection (G) is required for electromagnetic compatibility (EMC) and is not a protective earth ground.

Quick Setup Instructions

These instructions assume the meter is set to factory defaults. If it has been previously configured, all optional values should be checked.

1. Press the  or  button repeatedly until **SETUP** screen appears.
2.  to the **PASWD** screen.
3.  through the digits. Use the  or  buttons to select the password (the default is 00000). Exit the screen to the right.
4. Use the  or  buttons to select the parameter to configure.
5. If the unit has an RS-485 interface, the first Setup screen is **S COM** (set communications).
 - a.  to the **ADDR** screen and through the address digits. Use the  or  buttons to select the Modbus address.
 - b.  to the **BAUD** screen. Use the  or  buttons to select the baud rate.
 - c.  to the **PAR** screen. Use the  or  buttons to select the parity.
 - d.  back to the **S COM** screen.
6.  to the **S CT** (Set Current Transducer) screen. If this unit does not have an RS-485 port, this will be the first screen.
 - a.  to the **CT V** screen. Use the  or  buttons to select the voltage mode Current Transducer output voltage.
 - b.  to the **CT SZ** screen and through the digits. Use the  or  buttons to select the CT size in amps.
 - c.  back to the **S CT** screen.
7.  to the **S SYS** (Set System) screen.
 - a.  to the **SYSTEM** screen. Use the  or  buttons to select the System Type (see wiring diagrams).
 - b.  back to the **S SYS** screen.
8. (Optional)  to the **S PT** (Set Potential Transformer) screen. If PTs are not used, then skip this step.
 - a.  to the **PATIO** screen and through the digits. Use the  or  buttons to select the Potential Transformer step down ratio.
 - b.  back to the **S PT** screen.
9.  to the **S V** (Set System Voltage) screen.
 - a.  to the **VLL** (or **VLN** if system is 1L-1n) screen and through the digits. Use the  or  buttons to select the Line to Line System Voltage.
 - b.  back to the **S V** screen.
10. Use the  to exit the setup screen and then **SETUP**.
11. Check that the wrench is not displayed on the LCD.
 - a. If the wrench is displayed, use the  or  buttons to find the **ALERT** screen.
 - b.  through the screens to see which alert is on.

For full setup instructions, see the configuration instructions on the following pages.

Solid State Output

The E50 have one normally open (N.O.) KY Form A output and one normally closed (N.C.) output.* One is dedicated to energy (Wh), and the other to Alarm. The E50B1 also provides an additional N.O. reactive energy (VARh) contact. See the Setup section for configuration information.

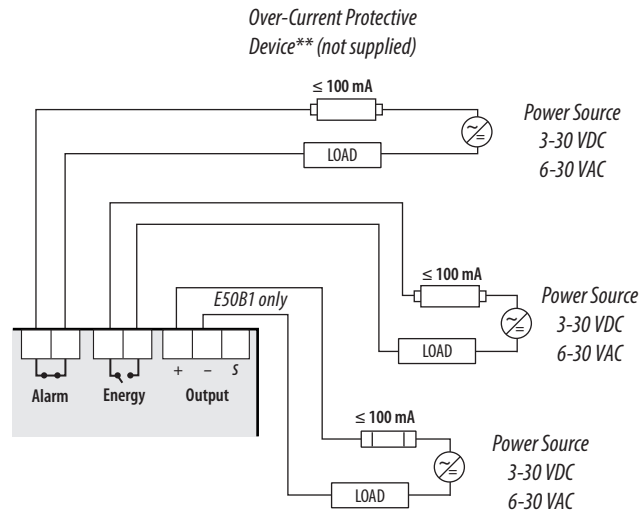

The solid state pulse outputs are rated for 30 VAC/DC nom.

Maximum load current is 100mA at 25°C. Derate 0.56 mA per °C above 25°C.

** While the relay used for the Phase Loss contact is Normally Closed (contacts are closed when the meter is not powered), closure indicates the presence of an alarm; either loss of phase, when the meter is powered, or loss of power when the meter is not. The contacts are open when the meter is powered and no phase loss alarm conditions are present*

*** Use an over-current protective device rated for the short circuit current at the connection point.*

User Interface (UI) Menu Abbreviations Defined

The user can set the display mode to either IEC or IEEE notation in the SETUP menu.

Main Menu		
IEC	IEEE	Description
D	D	Demand
MAX	M	Maximum Demand
P	W	Present Real Power
Q	VAR	Present Reactive Power
S	VA	Present Apparent Power
A	A	Amps
UAB, UBC, UAC	VAB, VBC, VAC	Voltage Line to Line
V	VLN	Voltage Line to Neutral
PF	PF	Power Factor
U	VLL	Voltage Line to Line
HZ	HZ	Frequency
KSh	KVAh	Accumulated Apparent Energy
KQh	KVARh	Accumulated Reactive Energy
KPh	KWh	Accumulated Real Energy
PLOSS	PLOSS	Phase Loss
LOWPF	LOWPF	Low Power Factor Error

Main Menu		
IEC	IEEE	Description
F ERR	F ERR	Frequency Error
I OVR	I OVR	Over Current
V OVR	V OVR	Over Voltage
PULSE	PULSE	kWh Pulse Output Overrun (configuration error)
_PHASE	_PHASE	Summary Data for 1, 2, or 3 active phases
ALERT	ALERT	Diagnostic Alert Status
INFO	INFO	Unit Information
MODEL	MODEL	Model Number
OS	OS	Operating System
RS	RS	Reset System
SN	SN	Serial Number
RESET	RESET	Reset Data
PASWD	PASWD	Enter Reset or Setup Password
ENERG	ENERG	Reset Energy Accumulators
DEMND	DEMND	Reset Demand Maximums

User Interface for Data Configuration

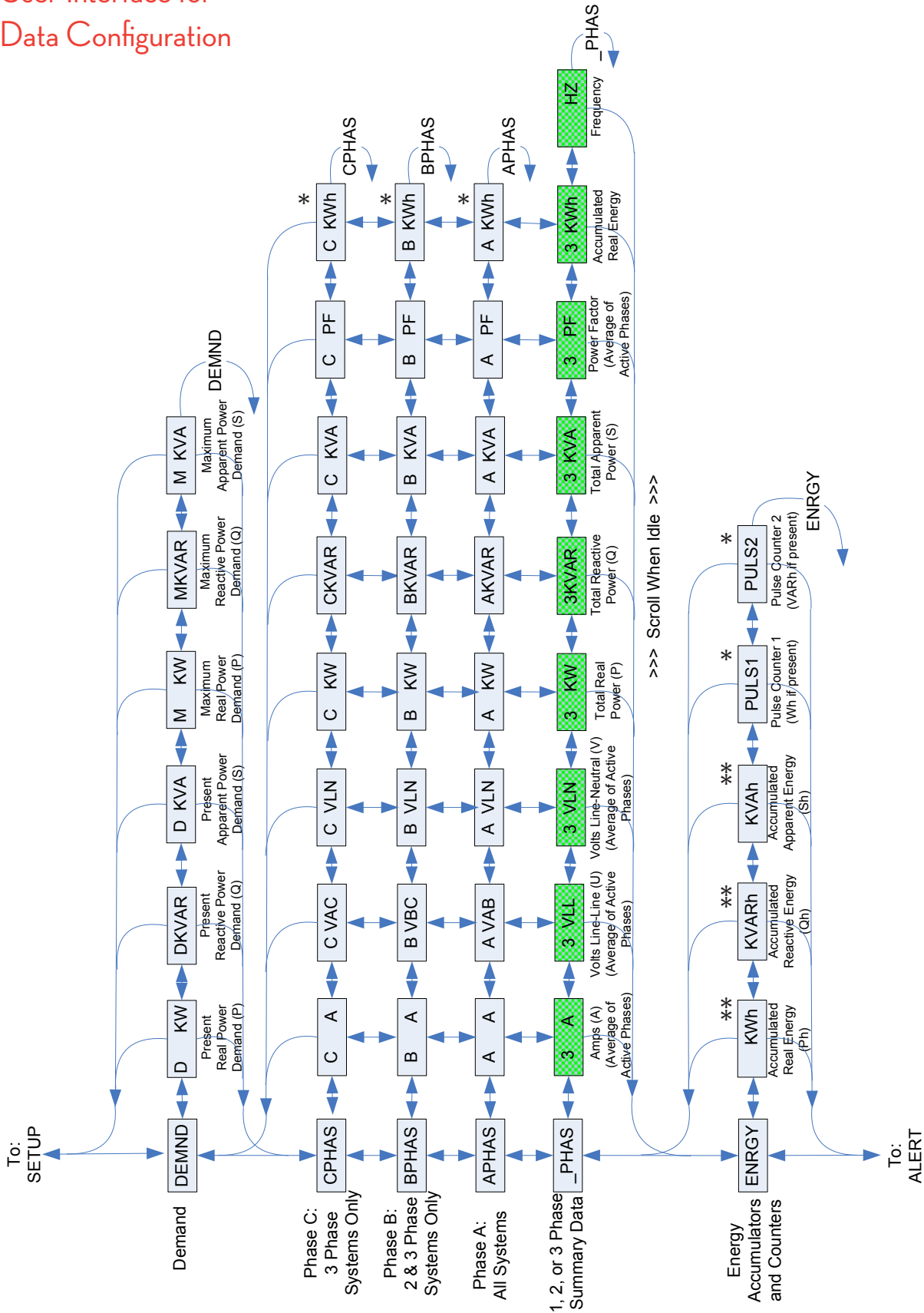

* This screen is not available in units with firmware versions 1.018 or earlier.
** This screen is part of the Phase Summary Data in units with firmware versions 1.018 or earlier.

Alert/Reset Information

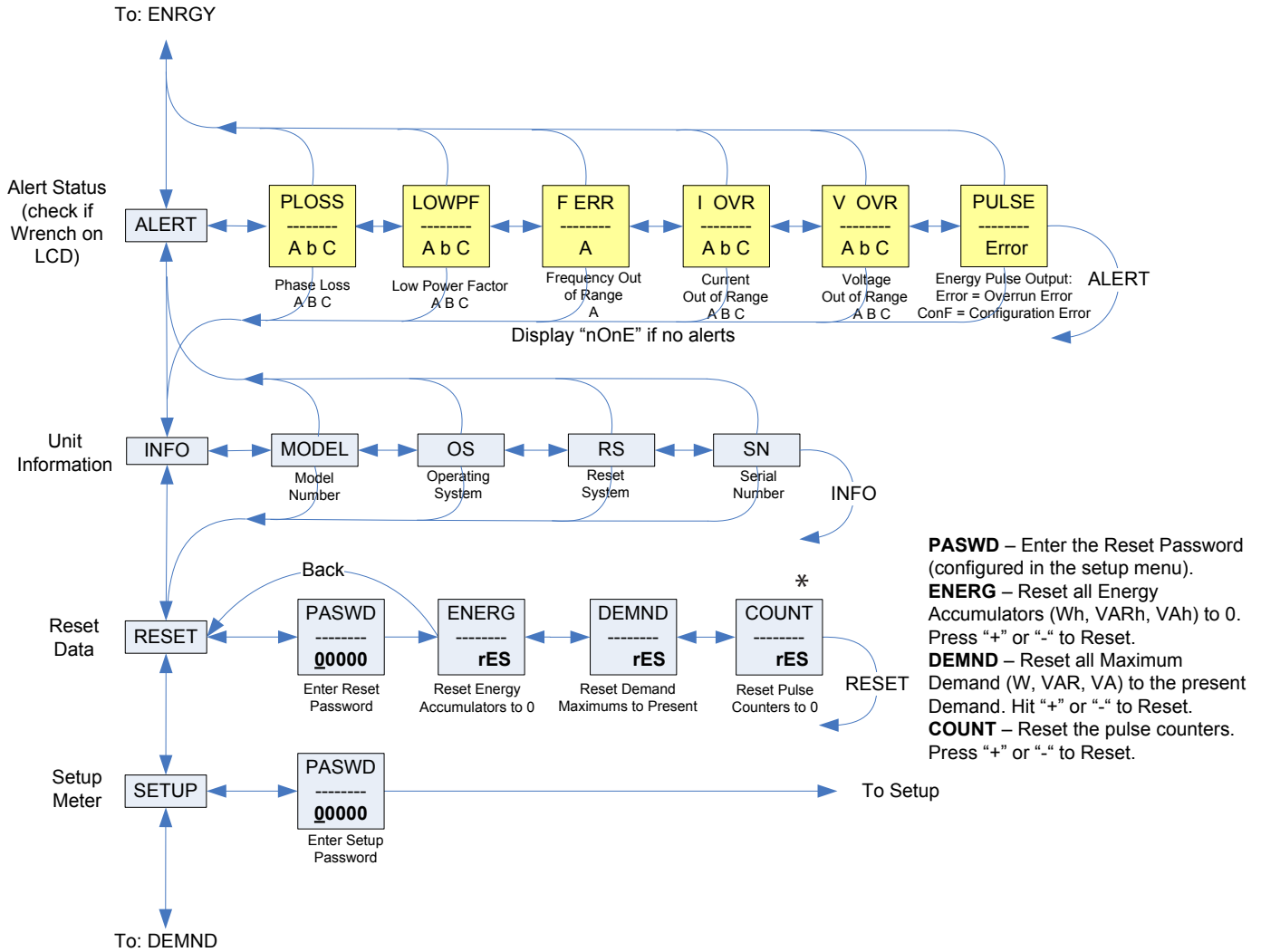

* This screen is not available in units with firmware versions 1.018 or earlier.

UI for Setup

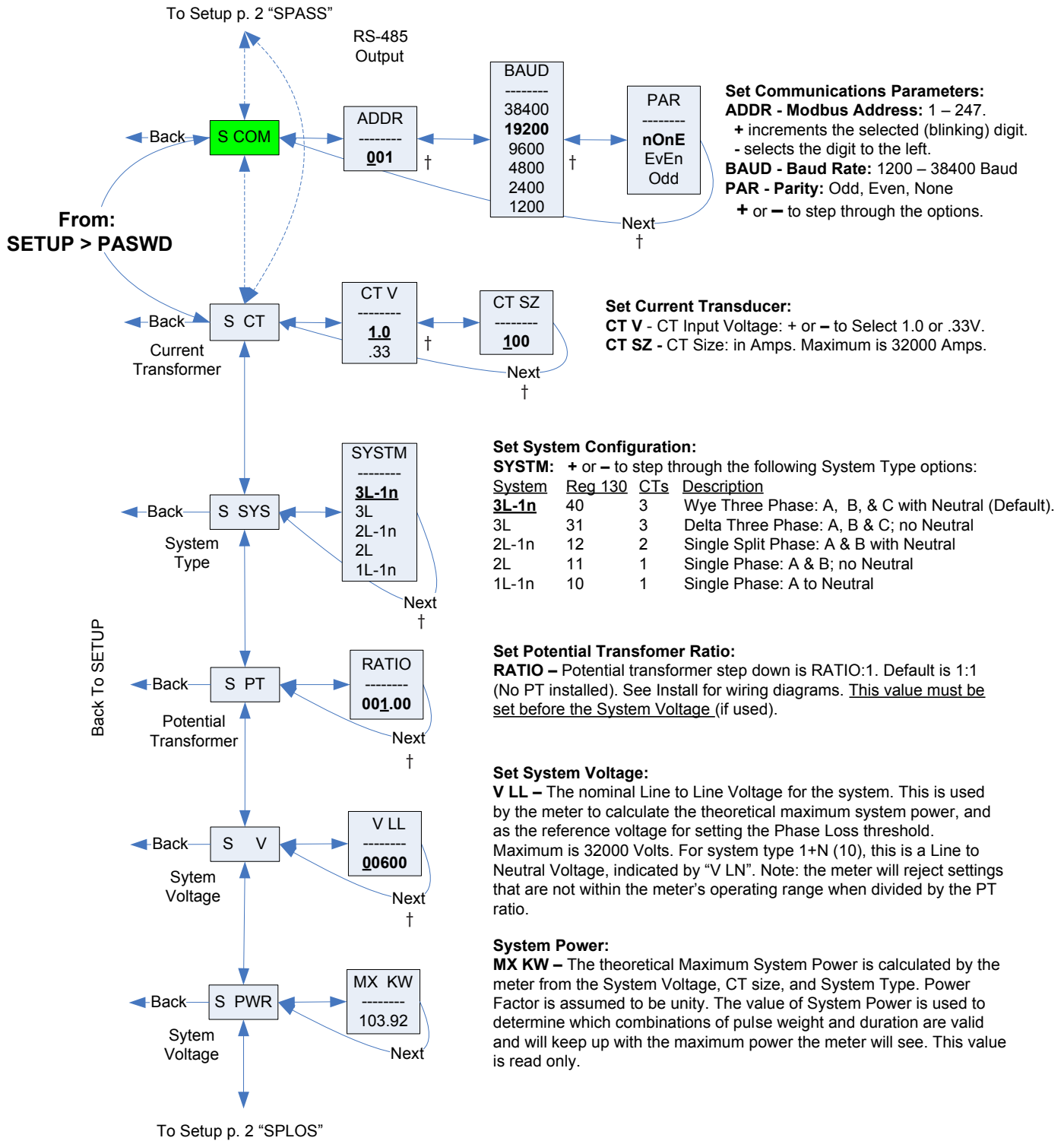

Note: **Bold** is the Default.

† When leaving this parameter screen using the right button (➡), the display will briefly indicate "SAvEd)" to confirm that any changes made have been accepted.

UI for Setup (cont.)

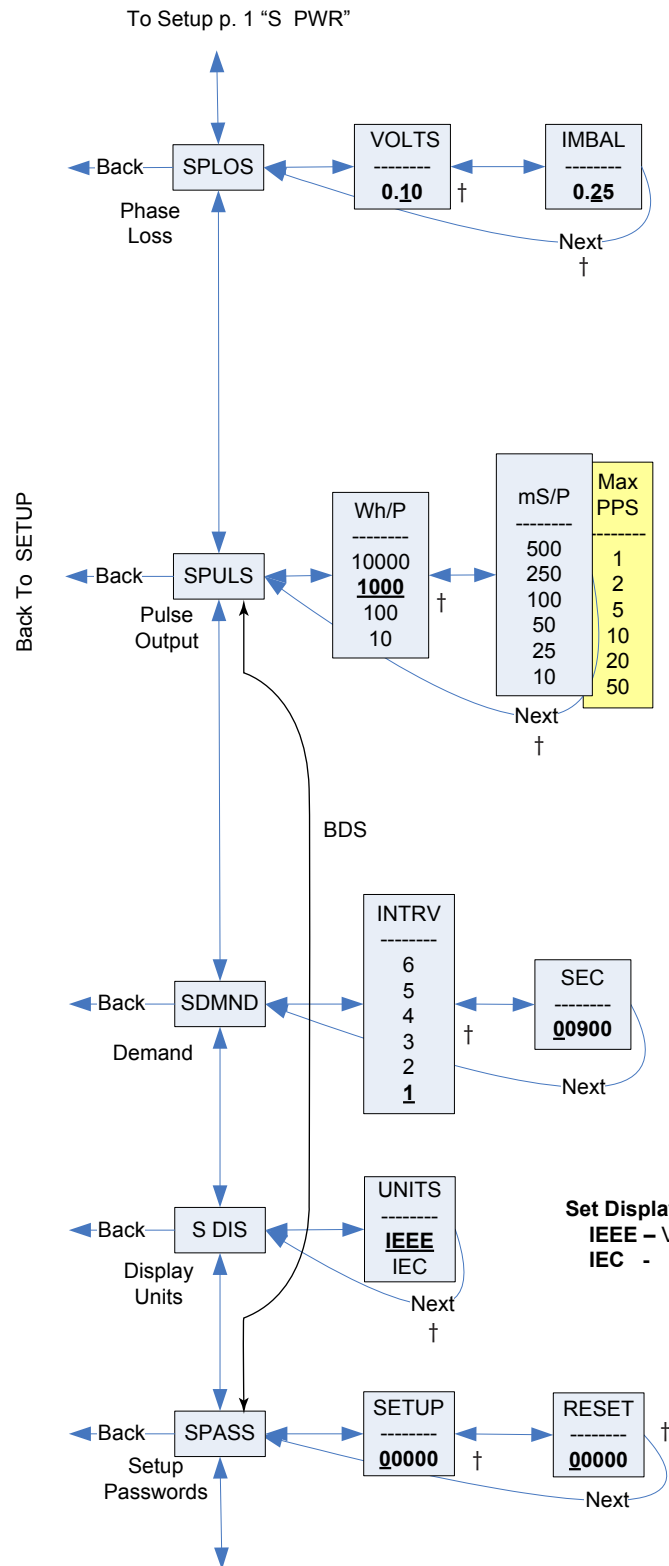

Set Phase Loss:

VOLTS - Phase Loss Voltage: The fraction of the system voltage below which Phase Loss Alarm is on. For system types with neutral, the Line to Neutral voltage is also calculated and tested. If the System Voltage is 600 and the fraction is set to 0.10, then the Phase Loss threshold will be 60 volts.

IMBAL - Phase Loss Imbalance: The fractional difference in Line to Line voltages above which Phase Loss Alarm is on. For system types with neutral, the Line to Neutral voltages are also tested. For system types 1+N (10) and 2 (11), imbalance is not tested.

Set Pulse:

The System Type, CT size, PT Ratio, and System Voltage must all be configured before setting the Pulse Energy. If any of these parameters are changed, the meter will hunt for a new Pulse Duration, but will not change the Pulse Energy. If it cannot find a solution, the meter will display the wrench, show "ConF" in the ALARM -> PULSE screen, and enable Energy pulse output configuration error bit in the Modbus Diagnostic Alert Bitmap (if equipped).

Wh/P - Set Pulse Energy: In Watt Hours (& VAR Hours, if present) per Pulse. When moving down to a smaller energy, the meter will not allow the selection if it cannot find a pulse duration that will allow the pulse output to keep up with Theoretical Maximum System Power (see S_PWR screen). When moving up to a larger energy, the meter will jump to the first value where it can find a valid solution.

mS/P - Minimum Pulse Duration Time: This read only value is set by the meter to the slowest duration (in mS per closure) that will keep up with the Theoretical Maximum System Power. The open time is greater than or equal to the closure time. The maximum Pulses Per Second (PPS) is shown in yellow.

Set Demand Interval:

INTRV - The number of Sub-Intervals (1 to 6) in a Demand Interval. Default is 1 (block demand).

SEC - Sub-Interval length in seconds. Default is 900 (15 minutes). Set to 0 for external sync-to-comms (Modbus units only).

Set Display Units: +/- to switch between:

IEEE - VLL VLN W VAR VA Units.
IEC - U V P Q S Units.

Set Passwords:

SETUP - The Password to enter the SETUP menu.
RESET - The Password to enter the RESET menu.

† When leaving this parameter screen using the right button (➡), the display will briefly indicate "SAvEd" to confirm that any changes made have been accepted.

RS-485 Communications (E50Cx only)

Daisy-chaining Devices to the Power Meter

The RS-485 slave port allows the power meter to be connected in a daisy chain with up to 63 2-wire devices.

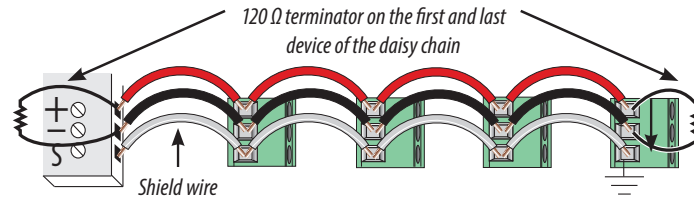

Notes

- The terminal's voltage and current ratings are compliant with the requirements of the EIA RS-485 communications standard.
- The RS-485 transceivers are ¼ unit load or less.
- RS-485+ has a 47 kΩ pull up to +5V, and RS-485- has a 47 kΩ pull down to Shield (RS-485 signal ground).
- Wire the RS-485 bus as a daisy chain from device to device, without any stubs. Use 120 Ω termination resistors at each end of the bus (not included).
- Shield is not internally connected to Earth Ground.
- Connect Shield to Earth Ground somewhere on the RS-485 bus.

For all terminals:

- When tightening terminals, apply the correct torque: 0.37 to 0.44 ft-lb (0.5-0.6 N-m).
- Use 14-24 gauge (2.1-0.2 mm²) wire.

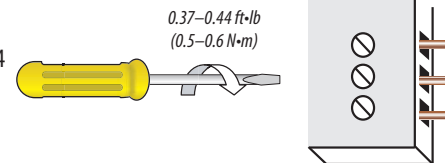

Data Logging (E50C3 only)

The E50C3 includes a data logging feature that records 10 meter parameters, each in its own buffer.

Configuration

Use register 150 to set the data logging time subinterval. Writing to the storage buffer is triggered by the subinterval timer. The default subinterval is 15 minutes (at a 15 minute interval setting, the buffers hold 60 days of data). An external timer can be used over Modbus by setting this register to 0.

Use register 159 to turn on data logging and select either Single Shot or Continuous mode. (default is data logging on, Continuous mode). In Single Shot mode, the meter records data until the buffer is full. When the buffer is full, the meter stops recording new readings. Data for this time period is kept, but newer energy information is lost. In Continuous mode, the meter continues to record energy data as long as the meter is operating. The buffer can only hold 5760 entries at one time, however, so when the number of records exceeds 5760, the oldest entry is deleted to make room for the newest.

Registers 169-178 contain the pointers to 10 data storage buffers. Each buffer is user-configurable with the Modbus address of the 16-bit data output to be stored. 32-bit data, such as floating point data or 32-bit integer energy accumulators, require two buffers. However, the lower 16 bits of an integer energy accumulator can be stored in a single buffer (optional).

When the E50C3 is first installed, the buffers contain QNAN data, with a value of 0x8000. This data is considered invalid. If the buffer is reset at any point, all entries in the buffers are overwritten with this 0x8000 value, indicating that it is invalid. All invalid data is overwritten as the meter fills the buffer with new data entries.

Reading Data

Use register 158 to choose which buffer to read. When this register value is set to 0, the meter is in data logging mode. Changing this value from 0 to (1 through 10) switches the meter to reading mode and selects a buffer to read. Data from the selected buffer appears in registers 8000 to 13760.

Data Logging
(E5OC3 only,
cont.)

Read/Write Collision

If the demand sub-interval timeout occurs while the user is reading a page (register 158 \neq 0), the log data will be held in RAM until the next demand subinterval. At that time, both the saved data from the previous cycle and the new data will be written to the log, whether the page register has been set back to 0 or not. Error bits in the Log Status Register (160) track these conditions. Subsequent log writes will proceed normally. Provided the log read is concluded in less time than the demand sub-interval, this mechanism handles the occasional collision and prevents the user from reading data as the buffer is being updated.

The Log Status Register has additional error flag bits that indicate whether logging has been reset or interrupted (power cycle, etc.) during the previous demand sub-interval, and whether the Real-Time Clock has been changed (re-initialized to default date/time due to a power-cycle or modified via Modbus commands).

Standard Modbus
Default Settings

Setting	Value	Modbus Register
Setup Password	00000	–
Reset Password	00000	–
System Type	40 (3 + N) Wye	130
CT Primary Ratio (if CTs are not included)	100A	131
CT Secondary Ratio	1V	132
PT Ratio	1:1 (none)	133
System Voltage	600 V L-L	134
Max. Theoretical Power (Analog Output: full scale (20mA or 5V))	104 kW	135
Display Mode	1 (IEEE)	137
Phase Loss	10% of System Voltage (60V), 25% Phase to Phase Imbalance	142, 143
Pulse Energy	1 (kWh/pulse)	144
Demand: number of sub-intervals per interval	1 (block mode)	149
Demand: sub-interval length	900 sec (15 min)	150
Modbus Address	001	–
Modbus Baud Rate	19200 baud	–
Modbus Parity	None	–
Log Read Page	0	158
Logging Configuration Register	0	159
Log Register Pointer 1	1 (Real Energy MSR)	169
Log Register Pointer 2	2 (Real Energy LSR)	170
Log Register Pointer 3	29 (Reactive Energy MSR)	171
Log Register Pointer 4	30 (Reactive Energy LSR)	172
Log Register Pointer 5	37 (Real Demand)	173
Log Register Pointer 6	38 (Reactive Demand)	174
Log Register Pointer 7	39 (Apparent Demand)	175
Log Register Pointer 8	155 (Month/Day)	176
Log Register Pointer 9	156 (Year/Hour)	177
Log Register Pointer 10	157 (Minutes/Seconds)	178

Modbus Point Map Overview

The E50C2 Full Data Set (FDS) features data outputs such as demand calculations, per phase VA and VAR, and VAh VARh accumulators. The E50C3 data logging model adds configuration registers 155-178 and buffer reading at registers 8000-13760. For security reasons, configuration and resets on all E50 models are protected by a user configurable passcode. The meter supports variable CTs and PTs, allowing a much wider range of operation from 90V x 5A up to 32000V x 32000A. To promote this, the meter permits variable scaling of the 16-bit integer registers via the scale registers. The 32-bit floating point registers do not need to be scaled.

Integer registers begin at 001 (0x001). Floats at 257 (0x101). Configuration registers at 129 (0x081). Values not supported in a particular System Type configuration will report QNAN (0x8000 in Integer Registers, 0x7FC00000 in Floating Point Registers).

Supported Modbus Commands

Note: ID String information varies from model to model. Text shown here is an example.

Command	Description
0x03	Read Holding Registers
0x04	Read Input Registers
0x06	Preset Single Register
0x10	Preset Multiple Registers
0x11	Report ID Return string: byte0: address byte1: 0x11 byte2: #bytes following w/out crc byte3: ID byte = 247 byte4: status = 0xFF if the operating system is used; status = 0x00 if the reset system is used bytes5+: ID string = "Veris Industries E50xx Power Meter Full Data Set" or "Veris Industries E50xx Power Meter - RESET SYSTEM RUNNING RS Version x.xxx" last 2 bytes: CRC
0x2B	Read Device Identification, BASIC implementation (0x00, 0x01 and 0x02 data), Conformity Level 1. Object values: 0x01: "Veris Industries" 0x02: "E50xx" 0x03: "Vxx.yyy", where xx.yyy is the OS version number (reformatted version of the Modbus register #7001, (Firmware Version, Operating System). If register #7001 == 12345, then the 0x03 data would be "V12.345").

Legend

The following table lists the addresses assigned to each data point. For floating point format variables, each data point appears twice because two 16-bit addresses are required to hold a 32-bit float value.

R/W	R=read only; R/W=read from either int or float formats, write only to integer format.	
NV	Value is stored in non-volatile memory. The value will still be available if the meter experiences a power loss and reset.	
Format	UInt	Unsigned 16-bit integer.
	SInt	Signed 16-bit integer.
	ULong	Unsigned 32-bit integer; Upper 16-bits (MSR) in lowest-numbered / first listed register (001/002 = MSR/LSR).
	Float	32-bit floating point; Upper 16-bits (MSR) in lowest-numbered / first listed register (257/258 = MSR/LSR). Encoding is per IEEE standard 754 single precision.
Units	Lists the physical units that a register holds.	
Scale Factor	Some Integer values must be multiplied by a constant scale factor (typically a fraction), to be read correctly. This is done to allow integer numbers to represent fractional numbers.	
Range	Defines the limit of the values that a register can contain.	

Modbus Point Map

E50C2 FDS	E50C3 Log	E50xx REG.	R/W	NV	Format	Units	Scale	Range	Description	
Integer Data										
•	•	001	R	NV	ULong	kWh	E	0-0xFFFF	Real Energy Consumption (MSR)	Clear via reset register
•	•	002	R					0-0xFFFF	Real Energy Consumption (LSR)	
•	•	003	R		UInt	kW	W	0-32767	Total Instantaneous Real Power (3 Phase Total)	
•	•	004	R		UInt	kVAR	W	0-32767	Total Instantaneous Reactive Power (3 Phase Total)	
•	•	005	R		UInt	kVA	W	0-32767	Total Instantaneous Apparent Power (3 Phase Total)	
•	•	006	R		UInt	Ratio	0.0001	0-10000	Total Power Factor (Total KW / Total KVA)	
•	•	007	R		UInt	Volt	V	0-32767	Voltage, L-L, Average of 3 Phases	
•	•	008	R		UInt	Volt	V	0-32767	Voltage, L-N, Average of 3 Phases	
•	•	009	R		UInt	Amp	I	0-32767	Current, Average of 3 Phases	
•	•	010	R		UInt	kW	W	0-32767	Real Power, Phase A	
•	•	011	R		UInt	kW	W	0-32767	Real Power, Phase B	
•	•	012	R		UInt	kW	W	0-32767	Real Power, Phase C	
•	•	013	R		UInt	Ratio	0.0001	0-10000	Power Factor, Phase A	
•	•	014	R		UInt	Ratio	0.0001	0-10000	Power Factor, Phase B	
•	•	015	R		UInt	Ratio	0.0001	0-10000	Power Factor, Phase C	
•	•	016	R		UInt	Volt	V	0-32767	Voltage, Phase A-B	
•	•	017	R		UInt	Volt	V	0-32767	Voltage, Phase B-C	
•	•	018	R		UInt	Volt	V	0-32767	Voltage, Phase A-C	
•	•	019	R		UInt	Volt	V	0-32767	Voltage, Phase A-N	
•	•	020	R		UInt	Volt	V	0-32767	Voltage, Phase B-N	
•	•	021	R		UInt	Volt	V	0-32767	Voltage, Phase C-N	
•	•	022	R		UInt	Amp	I	0-32767	Current, Instantaneous, Phase A	
•	•	023	R		UInt	Amp	I	0-32767	Current, Instantaneous, Phase B	
•	•	024	R		UInt	Amp	I	0-32767	Current, Instantaneous, Phase C	
•	•	025	R		UInt				Reserved; returns 0x8000 (QNaN)	
•	•	026	R		UInt	Hz	0.01	4500-6500	Frequency (derived from Phase A)	
•	•	027	R	NV	ULong	KVAh	E	0-0xFFFF	Apparent Energy Consumption (MSR)	Clear via reset register
•	•	028	R					0-0xFFFF	Apparent Energy Consumption (LSR)	
•	•	029	R	NV	ULong	KVARh	E	0-0xFFFF	Reactive Energy Consumption (MSR)	Clear via reset register
•	•	030	R					0-0xFFFF	Reactive Energy Consumption (LSR)	
•	•	031	R		UInt	kVA	W	0-32767	Apparent Power, Phase A	
•	•	032	R		UInt	kVA	W	0-32767	Apparent Power, Phase B	
•	•	033	R		UInt	kVA	W	0-32767	Apparent Power, Phase C	
•	•	034	R		UInt	kVAR	W	0-32767	Reactive Power, Phase A	
•	•	035	R		UInt	kVAR	W	0-32767	Reactive Power, Phase B	
•	•	036	R		UInt	kVAR	W	0-32767	Reactive Power, Phase C	
•	•	037	R		UInt	kW	W	0-32767	Total Real Power Present Demand	
•	•	038	R		UInt	kVAR	W	0-32767	Total Reactive Power Present Demand	
•	•	039	R		UInt	kVA	W	0-32767	Total Apparent Power Present Demand	
•	•	040	R	NV	UInt	kW	W	0-32767	Total Real Power Max Demand	
•	•	041	R	NV	UInt	kVAR	W	0-32767	Total Reactive Power Max Demand	
•	•	042	R	NV	UInt	kVA	W	0-32767	Total Apparent Power Max Demand	

Modbus Point Map (cont.)

E50C2 FDS	E50C3 Log	E50xx REG.	R/W	NV	Format	Units	Scale	Range	Description			
•	•	043*	R	NV	ULong			0-0xFFFF	Pulse Counter 1 (Real Energy)	MSR	Contact Closure Counters. Valid for both Pulse inputs and outputs. E50xx counts are shown in (). See register 144 (Energy per Pulse) for the Wh per pulse count. Clear via register 129. Inputs are user defined.	
•	•	044*								LSR		
•	•	045*	R	NV	ULong			0-0xFFFF	Pulse Counter 2 (Reactive Energy)	MSR		
•	•	046*								LSR		
•	•	047*	R	NV	ULong	kWh	E	0-0xFFFF	Real Energy Consumption Phase A	MSR		Clear via reset register
•	•	048*								LSR		
•	•	049*	R	NV	ULong	kWh	E	0-0xFFFF	Real Energy Consumption Phase B	MSR		
•	•	050*								LSR		
•	•	051*	R	NV	ULong	kWh	E	0-0xFFFF	Real Energy Consumption Phase C	MSR		
•	•	052*								LSR		
Configuration												
•	•	129	R/W		UInt			N/A	Command Register: - Write 30078 (0x757E) to clear all Energy Accumulators to 0. - Write 21211 (0x52DB) to begin new Demand Sub-Interval calculation cycle. Takes effect at the end of the next 1 second calculation cycle. Write no more frequently than every 10 seconds. - Write 21212 (0x52DC) to reset Max Demand values to Present Demand Values. Takes effect at the end of the next 1 second calculation cycle. Write no more frequently than every 10 seconds. - Write 16640 (0x4100) to Reset Logging (E50C3 only). - Write 16498 (0x4072) to Clear Pulse Counters to 0. - Read always returns 0.			
•	•	130	R/W	NV	UInt			10, 11, 12, 31, 40	Single Phase: A + N Single Phase: A + B Single Split Phase: A + B + N 3 phase Δ, A + B + C, no N 3 phase Y, A + B + C + N	System Type (See Manual. Note: only the indicated phases are monitored for Phase Loss)		
•	•	131	R/W	NV	UInt	Amps		1-32000	CT Ratio – Primary	Current Inputs		
•	•	132	R/W	NV	UInt			1, 3	CT Ratio – Secondary Interface (1 or 1/3 V, may not be user configurable)			
•	•	133	R/W	NV	UInt		100	0.01-320.00	PT Ratio: The meter scales this value by 100 (i.e. entering 200 yields a potential transformer ratio of 2:1). The default is 100 (1.00:1), which is with no PT attached. Set this value before setting the system voltage (below)			
•	•	134	R/W	NV	UInt			82-32000	System Voltage: This voltage is line to line, except for system type 10 which is line to neutral. The meter uses this value to calculate the full scale power for the analog outputs and pulse configuration (below), and as full scale for phase loss (register 142). The meter will refuse voltages that are outside the range of 82-660 volts when divided by the PT Ratio (above).			
•	•	135	R	NV	UInt	kW	W	1-32767	Theoretical Maximum System Power: This read-only value is the theoretical max. power the meter can expect to see on a service. This value is 100% of scale on the analog output (0-5VDC or 4-20mA), if equipped. The meter recalculates this value if the user changes the CT size, system type, or system voltage. This integer value has the same scale as other integer power registers (see register 140 for power scaling).			
•	•	136	R		UInt				Reserved, always returns 0			
•	•	137	R/W	NV	UInt			0,1	Display Units: 0 = IEC (U, V, P, Q, S), 1 = IEEE (default: VLL, VLN, W, VAR, VA)			

Modbus Point Map (cont.)

E50C2 FDS	E50C3 Log	E50xx REG.	R/W	NV	Format	Units	Scale	Range	Description
•	•	138	R		SInt		-4 0.0001		Scale Factor I (Current)
•	•	139	R		SInt		-3 0.001		Scale Factor V (Voltage)
•	•	140	R		SInt		-2 0.01		Scale Factor W (Power)
•	•	141	R		SInt		-1 0.1		Scale Factor E (Energy)
							0 1.0		
							1 10.0		
							2 100.0		
							3 1000.0		
							4 10000.0		
•	•	142	R/W	NV	UInt	%		1-99	Phase Loss Voltage Threshold in percent of system voltage (register 134). Default is 10 (%). Any phase (as configured in register 130) that drops below this threshold triggers a Phase Loss alert - i.e. if the System voltage is set to 480 V L-L, the L-N voltage for each phase should be 277 V. When the threshold is set to 10%, if any phase drops more than 10% below 277 V, (less than 249 V), or if any L-L voltage drops more than 10% below 480 V (less than 432 V) the corresponding phase loss alarm bit in register 146 will be true.
									Phase Loss Output
									Note: The phases tested are determined by the System Type.
•	•	143	R/W	NV	UInt	%		1-99	Phase Loss Imbalance Threshold in Percent. Default is 25% phase to phase difference. For a 3-phase Y (3 + N) system type (40 in register 130), both Line to Neutral and Line to Line voltages are tested. In a 3-phase Δ System type (31 in register 130), only Line to Line voltages are examined. In a single split-phase (2 + N) system type (12 in register 130), just the line to neutral voltage are compared.
•	•	144	R/W	NV	UInt	Wh		10000, 1000, 100, 10	Wh (& VARh, if equipped with FDS) Energy per Pulse Output Contact Closure. If the meter cannot find a pulse duration that will keep up with the max. system power (register 135), it will reject the new value. Try a larger value.
									kWh Pulse Contacts
•	•	145	R	NV	UInt	ms		500, 250, 100, 50, 25, 10	Pulse Contact Closure Duration in msec. Read-only. Set to the slowest duration that will keep up with the theoretical max. system power (register 135). The open time ≥ the closure time, so the max. pulse rate (pulses per sec) is the inverse of double the pulse time.
									Note: The kWh pulse contact can keep up with a maximum power (Watts) of 1800000 x Wh pulse weight ÷ contact closure duration (in mses)

Modbus Point Map (cont.)

E50C2 FDS	E50C3 Log	E50xx REG.	R/W	NV	Format	Units	Scale	Range	Description				
•	•	146	R		UInt				Diagnostic Alert Bitmap. 1 = Active: Bit 0: Phase A Voltage out of range Bit 1: Phase B Voltage out of range Bit 2: Phase C Voltage out of range Bit 3: Phase A Current out of range Bit 4: Phase B Current out of range Bit 5: Phase C Current out of range Bit 6: Frequency out of the range of 45 – 65 Hz OR there is insufficient voltage to determine frequency. Bit 7: Reserved for future use Bit 8: Phase Loss A Bit 9: Phase Loss B Bit 10: Phase Loss C Bit 11: Low Power Factor on A with one or more phases having a PF less than 0.5 due to mis-wiring of phases Bit 12: Low Power Factor on B Bit 13: Low Power Factor on C Bit 14: Energy pulse output overrun error. The pulse outputs are unable to keep up with the total real power (registers 3 and 261/262). To fix, increase the pulse energy register (register 144) and reset the energy accumulators (see reset register 129). Bit 15: Energy pulse output configuration error (present pulse energy setting may not keep up with the theoretical max. system power; see register 135). To fix, increase the pulse energy (register 144).				
•	•	147	R	NV	UInt			0-32767	Count of Energy Accumulator resets				
•	•	148	R		UInt				Reserved (returns 0)				
•	•	149	R/W	NV	UInt			1-6	Number of Sub-Intervals per Demand Interval. Sets the number of sub-intervals that make a single demand interval. For block demand, set this to 1.				
•	•	150	R/W	NV	UInt	Seconds		0, 10-32767	Sub-Interval Length in seconds. For sync-to-comms, set this to 0 and use the reset register (129) to externally re-start the sub-interval. On the E50C3, this is also the logging interval.				
•	•	151	R/W		UInt			1-32767	Reserved (returns 0)				
•	•	152	R/W	NV	UInt			0-32767	Power Up Counter.				
•	•	153	R	NV	UInt			0-32767	Output Configuration. E50B1, E50C2, and E50C3 units have a NO (normally open) energy contact and NC (normally closed) (Normally Open - Form A or Normally Closed - Form B) Phase Loss contact. While the relay used for the Phase Loss contact is Normally Closed (contacts are closed when the meter is not powered), closure indicates the presence of an alarm; either loss of phase, when the meter is powered, or loss of power when the meter is not. The contacts are open when the meter is powered and no phase alarm conditions are present. 3rd Output: 0 = RS-485 2 = VAR Pulse				
•	•	154	R		UInt				Reserved, returns 0				
Logging Configuration and Status													
•	•	155	R/W	NV	UInt	Day / Month		See Bytes	<table border="1"> <thead> <tr> <th>Most Significant Byte (MSB)</th> <th>Least Significant Byte (LSB)</th> </tr> </thead> <tbody> <tr> <td>Day 1-31 (0x01-0x1F)</td> <td>Month 1-12 (0x01-0x0C)</td> </tr> </tbody> </table>	Most Significant Byte (MSB)	Least Significant Byte (LSB)	Day 1-31 (0x01-0x1F)	Month 1-12 (0x01-0x0C)
Most Significant Byte (MSB)	Least Significant Byte (LSB)												
Day 1-31 (0x01-0x1F)	Month 1-12 (0x01-0x0C)												
•	•	156	R/W	NV	UInt	Hour / Year		See Bytes	<table border="1"> <thead> <tr> <th>Hour 0-23 (0x00-0x17)</th> <th>Year 0-199 (0x00-0xC7)</th> </tr> </thead> <tbody> <tr> <td>Hour 00</td> <td>Year (20) 00</td> </tr> </tbody> </table>	Hour 0-23 (0x00-0x17)	Year 0-199 (0x00-0xC7)	Hour 00	Year (20) 00
Hour 0-23 (0x00-0x17)	Year 0-199 (0x00-0xC7)												
Hour 00	Year (20) 00												
•	•	157	R/W	NV	UInt	Seconds / Minutes		See Bytes	<table border="1"> <thead> <tr> <th>Seconds 0-59 (0x00-0x3B)</th> <th>Minutes 0-59 (0x00-0x3B)</th> </tr> </thead> <tbody> <tr> <td>Hour 00</td> <td>Year (20) 00</td> </tr> </tbody> </table>	Seconds 0-59 (0x00-0x3B)	Minutes 0-59 (0x00-0x3B)	Hour 00	Year (20) 00
Seconds 0-59 (0x00-0x3B)	Minutes 0-59 (0x00-0x3B)												
Hour 00	Year (20) 00												

Modbus Point Map (cont.)

E50C2 FDS	E50C3 Log	E50xx REG.	R/W	NV	Format	Units	Scale	Range	Description		
		• 158	R/W	NV	UInt			0-10	Logging Read Page Register. Selects which of the Register Logs to read (see registers 169-178). 1-10 are valid entries that put the meter into log reading mode, temporarily pausing logging. When set to 0 (no variable selected for reading), normal logging resumes. The meter will buffer one set of log entries while in reading mode if a sub-interval timeout occurs (read/write collision). Default is 0. Warning: this buffered data will be written to the log and logging will resume on the following sub-interval timeout whether the page register has been cleared or not, resulting in the appearance of data moving in the buffer during reads. To avoid this, log buffer reads should be completed and this register set back to 0 in less time than the Demand Sub-interval (preferred) or logging should be halted by setting Bit 1 in register 158 (logs may be missed)		
		• 159	R/W	NV	UInt				Logging Configuration Register (Bit Mapped): Bit 0: Clear to 0 for Continuous log buffer mode. Set to 1 for Single Shot logging mode. Default is 0 (Continuous). Bit 1: Clear to 0 to enable Logging. Set to 1 to halt logging. Default is 0 (Log).		
		• 160	R	NV	UInt				Logging Status Register (Bit Mapped): Bit 0: Log buffer full – Set to 1 when one single shot mode has filled the log buffer. The Logged Entry Count will continue to increment. Cleared to 0 when logging is restarted (see reset command register 129). Bit 1: Log Buffer Read Collision 1 – Set to 1 if the meter tried to save log data while the user was reading the log (Logging Page Register has been set to something other than 0). On the first collision, the meter holds the data until the next sub-interval and then writes the saved data to the log as well as the data for that interval. This bit is cleared to 0 on the first demand interval with Logging Page Register = 0. Bit 2: Log Buffer Read Collision 2 – Set to 1 on the 2nd attempt to save log data while the user is reading the log (Logging Page Register is set to something other than 0). At this point the meter ignores the read condition and does a double write, first of the values saved from the previous cycle, and then the present values. If the read condition is not removed the meter continues to write the log data as it normally would. This bit is cleared to 0 on the first demand interval with Logging Page Register = 0. Bit 3: Logging Reset – The Log has been reset during the previous demand sub-interval. Bit 4: Logging Interrupted – Logging has been interrupted (power cycled, log configuration change, etc.) during the previous demand sub-interval. Bit 5: RTC Changed – The Real Time Clock has been changed during the previous demand sub-interval. Bit 6: RTC Reset – The Real Time Clock has been reset to the year 2000 and needs to be re-initialized.		
		• 161	R	NV	UInt			0-32767	Log Buffer Wrap / Missed Log Counter. In continuous mode, this counter increments each time the internal circular log buffer wraps and overwrites old data. The total number of logged entries since the last log reset is: (Register 161 x 5760) + Register 163. In single shot mode this counter is the number of log entries lost due to the buffer being full. The counter is cleared on logging reset.		
		• 162	R	NV	UInt			0-32767	Max Number of Logging Days. Based on the Sub-Interval Length and the depth of the log buffer, this register shows the maximum number of days that data will be logged following a reset until the Buffer is full (Single Shot Mode) or overwrites old data (Continuous).		
		• 163	R	NV	UInt			0-32767	Number of Logged Entries since the log buffer wrapped or was reset. In single shot mode, this is the total number of valid entries in the buffer. Any entries beyond this will read back as QNAN (0x8000).		
		• 164	R	NV	ULong	kWh	E	0-0xFFFF	Real Energy Consumption (MSR)	Real Energy (Register 001/002) at the time of the most recent log entries.	
		• 165						0-0xFFFF	Real Energy Consumption (LSR)		
		• 166	R	NV	UInt	Month / Day		See Bytes	Most Significant Byte (MSB)	Least Significant Byte (LSB)	Date & Time of the newest entry in the log. After a power cycle, resets to: Day 01 Month 01 Hour 00 Year (20) 00
									Day 1-31 (0x01-0x1F)	Month 1-12 (0x01-0x0C)	
		• 167	R	NV	UInt	Year / Hour		See Bytes	Hour 0-23 (0x00-0x17)	Year 0-199 (0x00-0xC7)	
		• 168	R	NV	UInt	Minutes / Seconds		See Bytes	Seconds 0-59 (0x00-0x3B)	Minutes 0-59 (0x00-0x3B)	

Modbus Point Map (cont.)

E50C2 FDS	E50C3 Log	E50xx REG.	R/W	NV	Format	Units	Scale	Range	Description
	•	169	R/W	NV	UInt			1-42, 146, 155-157, 257-336	Log Register Pointer 1 – Default is 1 (Real Energy MSR)
	•	170	R/W	NV	UInt				Log Register Pointer 2 – Default is 2 (Real Energy LSR)
	•	171	R/W	NV	UInt				Log Register Pointer 3 – Default is 29 (Reactive Energy MSR)
	•	172	R/W	NV	UInt				Log Register Pointer 4 – Default is 30 (Reactive Energy LSR)
	•	173	R/W	NV	UInt				Log Register Pointer 5 – Default is 37 (Real Demand)
	•	174	R/W	NV	UInt				Log Register Pointer 6 – Default is 38 (Reactive Demand)
	•	175	R/W	NV	UInt				Log Register Pointer 7 – Default is 39 (Apparent Demand)
	•	176	R/W	NV	UInt				Log Register Pointer 8 – Default is 155 (Month/Day)
	•	177	R/W	NV	UInt				Log Register Pointer 9 – Default is 156 (Year/Hour)
	•	178	R/W	NV	UInt				Log Register Pointer 10 – Default is 157 (Minutes/Seconds)
Floating Point Data									
•	•	257/258	R	NV	Float	kWh			Real Energy Consumption (clear via reset register)
•	•	259/260	R	NV	Float	kWh			Real Energy Consumption (clear via reset register)
•	•	261/262	R		Float	kW			Total Instantaneous Real Power
•	•	263/264	R		Float	kVAR			Total Instantaneous Reactive Power
•	•	265/266	R		Float	kVA			Total Instantaneous Apparent Power
•	•	267/268	R		Float	Ratio	0.0-1.0		Total Power Factor (Total KW / Total KVA)
•	•	269/270	R		Float	Volt			Voltage, L-L, Average of 3 Phases
•	•	271/272	R		Float	Volt			Voltage, L-N, Average of 3 Phases
•	•	273/274	R		Float	Amp			Current, Average of 3 Phases
•	•	275/276	R		Float	kW			Real Power, Phase A
•	•	277/278	R		Float	kW			Real Power, Phase B
•	•	279/280	R		Float	kW			Real Power, Phase C
•	•	281/282	R		Float	Ratio	0.0-1.0		Power Factor, Phase A
•	•	283/284	R		Float	Ratio	0.0-1.0		Power Factor, Phase B
•	•	285/286	R		Float	Ratio	0.0-1.0		Power Factor, Phase C
•	•	287/288	R		Float	Volt			Voltage, Phase A-B
•	•	289/290	R		Float	Volt			Voltage, Phase B-C
•	•	291/292	R		Float	Volt			Voltage, Phase A-C
•	•	293/294	R		Float	Volt			Voltage, Phase A-N
•	•	295/296	R		Float	Volt			Voltage, Phase B-N
•	•	297/298	R		Float	Volt			Voltage, Phase C-N
•	•	299/300	R		Float	Amp			Current, Instantaneous, Phase A
•	•	301/302	R		Float	Amp			Current, Instantaneous, Phase B
•	•	303/304	R		Float	Amp			Current, Instantaneous, Phase C
•	•	305/306	R		Float				Reserved, returns 0x7FC00000 (QNaN)
•	•	307/308	R		Float	Hz	45.0-65.0		Frequency (derived from Phase A)
•	•	309/310	R	NV	Float	kVAh			Apparent Energy Consumption

Modbus Point Map (cont.)

E5OC2 FDS	E5OC3 Log	E50xx REG.	R/W	NV	Format	Units	Scale	Range	Description
•	•	311/312	R	NV	Float	kVARh			Reactive Energy Consumption
•	•	313/314	R		Float	kVA			Apparent Power, Phase A
•	•	315/316	R		Float	kVA			Apparent Power, Phase B
•	•	317/318	R		Float	kVA			Apparent Power, Phase C
•	•	319/320	R		Float	kVAR			Reactive Power, Phase A
•	•	321/322	R		Float	kVAR			Reactive Power, Phase B
•	•	323/324	R		Float	kVAR			Reactive Power, Phase C
•	•	325/326	R		Float	kW			Total Real Power Present Demand
•	•	327/328	R		Float	kVAR			Total Reactive Power Present Demand
•	•	329/330	R	NV	Float	kVA			Total Apparent Power Present Demand
•	•	331/332	R	NV	Float	kW			Total Real Power Max Demand
•	•	333/334	R	NV	Float	kVAR			Total Reactive Power Max Demand
•	•	335/336	R	NV	Float	kVA			Total Apparent Power Max Demand
•	•	337/338*	R		Float			0 - 4294967040	Pulse Counter 1 (Real Energy)
•	•	339/340*	R		Float			0 - 4294967040	Contact Closure Counters. Valid for both Pulse inputs and outputs. E50xx counts are shown in (). See register 144 (Energy per Pulse) for the Wh per pulse count. Clear via register 129. Inputs are user defined. These values are derived from the 32 bit integer counter and will roll over to 0 when the integer counters do.
•	•	341/342*	R	NV	Float	kWh			Real Energy Consumption, Phase A
•	•	343/344*	R	NV	Float	kWh			Real Energy Consumption, Phase B
•	•	345/346*	R	NV	Float	kWh			Real Energy Consumption, Phase C
Logging Interface									
	•	8000	R	NV					Newest Logged Data Entry
		(to)							(to)
	•	13760	R	NV					Oldest Logged Data Entry
									5760 entries total (60 days at a 15 minute sub-interval)

Invalid or Quiet Not A Number (QNaN) conditions are indicated by 0x8000 (negative zero) for 16 bit integers and 0x7FC00000 for 32 bit floating point numbers.

Floating point numbers are encoded per the IEEE 754 32-bit specifications.

* Points 337/338 through 345/346 are not available on units with firmware versions 1.018 or earlier.

Troubleshooting

Problem	Cause	Solution
The maintenance wrench icon appears in the power meter display.	There is a problem with the inputs to the power meter.	See the Alert sub-menu or the Diagnostic Alert Modbus Register 146
The display is blank after applying control power to the meter.	The meter is not receiving adequate power.	Verify that the meter control power are receiving the required voltage. Verify that the heart icon is blinking. Check the fuse.
The data displayed is inaccurate.	Incorrect setup values	Verify the values entered for power meter setup parameters (CT and PT ratings, system type, etc.). See the Setup section.
	Incorrect voltage inputs	Check power meter voltage input terminals to verify adequate voltage.
	Power meter is wired improperly.	Check all CTs and PTs to verify correct connection to the same service, PT polarity, and adequate powering. See the Wiring Diagrams section for more information.
Cannot communicate with power meter from a remote personal computer.	Power meter address is incorrect.	Verify that the meter is correctly addressed (see Setup section).
	Power meter baud rate is incorrect.	Verify that the baud rate of the meter matches that of all other devices on its communications link (see Setup section).
	Communications lines are improperly connected.	Verify the power meter communications connections (see the Communications section). Verify the terminating resistors are properly installed on both ends of a chain of units. Units in the middle of a chain should not have a terminator. Verify the shield ground is connected between all units.

China RoHS Compliance Information (EFUP Table)

部件名称	产品中有害物质或元素的名称及含量Substances					
	铅 (Pb)	汞 (Hg)	镉 (Cd)	六价铬 (Cr (VI))	多溴联苯 (PBB)	多溴二苯醚 (PBDE)
电子线路板	X	0	0	0	0	0
0 = 表示该有毒有害物质在该部件所有均质材料中的含量均在 SJ/T11363-2006 标准规定的限量要求以下。 X = 表示该有毒有害物质至少在该部件的某一均质材料中的含量超出SJ/T11363-2006标准规定的限量要求。						
Z000057-0A						