

FILTER GRILLE PANEL

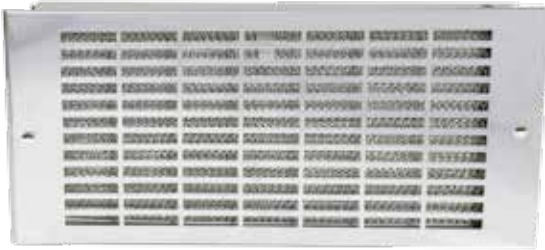

APPLICATION

Filter Grille Panels add valuable ventilation to a rack for either inlet or exhaust air. Used alone, filter grille panels allow adequate air flow on natural convection applications or in conjunction with an air moving device to provide filtered air intake.

FEATURES

- Permanent, Washable Aluminum Filter
- 19-inch Rack Mountable
- Brushed Aluminum or Stainless Steel Grilles

Performance Data Filter Grille Panel

CATALOG NUMBERS					
Stainless Steel	35G19	—	7G19	875G19	105G19
Aluminum	35H19	525H19	7H19	875H19	105H19
UNIT CONSTRUCTION					
Height PMax (in./mm)	3.5/89	5.25/133	7.00/178	8.75/222	10.50/267
Width (in./mm)	19/483	19/483	19/483	19/483	19/483
Weight (lb./kg)	2/1.0	3/1.4	5/2.2	5/2.2	5/2.2

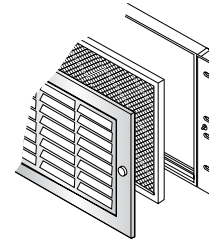
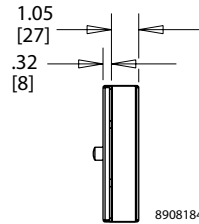
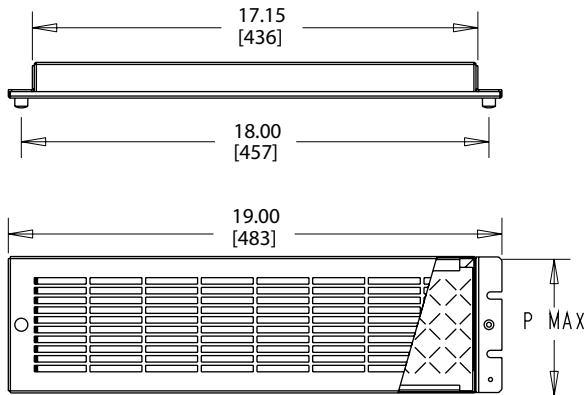

89081845

LOUVER PLATE KITS

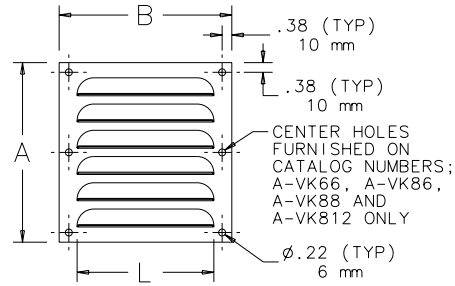

Designed to provide ventilation in enclosures where excessive internal heat or excessive moisture is a problem. Although louvers cannot keep all moisture out of an enclosure, gasketing or sealing the perimeter of the louver plate reduces problems associated with moisture intrusion. These kits may be easily installed in the field by making a cutout of the proper size and attaching the louver plate in place. Louver plates are made from 14 gauge steel with an ANSI 61 gray polyester powder finish over pretreated surfaces or 316 stainless steel. Hardware is furnished for mounting. Custom sizes, materials, finishes, etc., can be provided on special order.

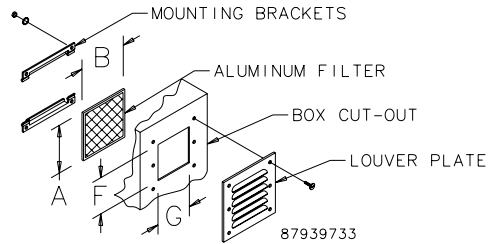

Design Data Louver Plate Kits

CATALOG NUMBERS	Dimensions		Number of Louvers	Thickness in./mm	Length L in./mm	Opening Area in. ² /cm ²	Cutout Size, F in./mm	Cutout Size, G in./mm
	A x B in./mm							
AVK23	3.25 x 3.25/83 x 83		3	0.19/5	2.00/51	.86/5.54	2.00/51	1.75/44
AVK23SS6	3.25 x 3.25/83 x 83		3	0.19/5	2.00/51	.86/5.54	2.00/51	1.75/44
AVK33	3.88 x 4.50/98 x 114		3	0.25/6	3.00/76	1.32/8.52	2.62/67	3.00/76
AVK33SS6	3.88 x 4.50/98 x 114		3	0.25/6	3.00/76	1.32/8.52	2.62/67	3.00/76
AVK34	4.75 x 4.50/121 x 114		4	0.25/6	3.00/76	1.76/11.35	3.50/89	3.00/76
AVK34SS6	4.75 x 4.50/121 x 114		4	0.25/6	3.00/76	1.76/11.35	3.50/89	3.00/76
AVK43	4.50 x 5.50/114 x 140		3	0.25/6	4.00/102	1.88/12.10	3.25/83	4.00/102
AVK43SS6	4.50 x 5.50/114 x 140		3	0.25/6	4.00/102	1.88/12.10	3.25/83	4.00/102
AVK44	5.62 x 5.50/143 x 140		4	0.25/6	4.00/102	2.50/16.13	4.38/111	4.00/102
AVK44SS6	5.62 x 5.50/143 x 140		4	0.25/6	4.00/102	2.50/16.13	4.38/111	4.00/102
AVK64	5.62 x 7.50/143 x 191		4	0.31/8	6.00/152	5.21/33.61	4.38/111	6.00/152
AVK64SS6	5.62 x 7.50/143 x 191		4	0.31/8	6.00/152	5.21/33.61	4.38/111	6.00/152
AVK66	7.88 x 7.50/200 x 191		6	0.31/8	6.00/152	7.82/50.45	6.62/168	6.00/152
AVK66SS6	7.88 x 7.50/200 x 191		6	0.31/8	6.00/152	7.82/50.45	6.62/168	6.00/152
AVK84	5.81 x 9.50/148 x 241		4	0.31/8	8.00/203	8.08/52.12	4.56/116	8.00/203
AVK84SS6	5.81 x 9.50/148 x 241		4	0.31/8	8.00/203	8.08/52.12	4.56/116	8.00/203
AVK86	8.19 x 9.50/208 x 241		6	0.31/8	8.00/203	12.11/78.13	6.94/176	8.00/203
AVK86SS6	8.19 x 9.50/208 x 241		6	0.31/8	8.00/203	12.11/78.13	6.94/176	8.00/203
AVK88	10.56 x 9.50/268 x 241		8	0.31/8	8.00/203	16.15/104.19	9.31/236	8.00/203
AVK88SS6	10.56 x 9.50/268 x 241		8	0.31/8	8.00/203	16.15/104.19	9.31/236	8.00/203
AVK812	15.31 x 9.50/389 x 241		12	0.31/8	8.00/203	24.22/156.26	14.06/357	8.00/203
AVK812SS6	15.31 x 9.50/389 x 241		12	0.31/8	8.00/203	24.22/156.26	14.06/357	8.00/203

Catalog numbers ending in SS6 indicates 316L stainless steel

LOUVER PLATE KIT FILTERS



Design

Designed for use with Louver Plate Kit. Mounting holes on filter bracket align with louver mounting holes. Hardware supplied with louvers also secures filter brackets in place. Aluminum air filters provide good arrestment of airborne dust and dirt.

Filter Media

Filter media is composed of layers of slit and expanded aluminum providing hundreds of adhesive coated baffle surfaces for trapping impurities. Impurities are held throughout the depth of the filter. Washing with warm water will keep the filter clean. To achieve best results, Filter Adhesive is recommended.

<i>CATALOG NUMBERS</i>	<i>Dimensions H x W (in./mm)</i>	<i>Use with Steel Louver</i>	<i>Use with Stainless Steel Louver</i>
AFLT33	3.22x 3.25/82 x 83	AVK33	AVK33SS6
AFLT34	4.09 x 3.25/104 x 83	AVK34	AVK34SS6
AFLT43	3.84 x 4.25/98 x 108	AVK43	AVK43SS6
AFLT44	4.97 x 4.25/126 x 108	AVK44	AVK44SS6
AFLT64	4.45 x 6.25/113 x 159	AVK64	AVK64SS6
AFLT66	6.72 x 6.25/171 x 159	AVK66	AVK66SS6
AFLT84	4.64 x 8.25/118 x 210	AVK84	AVK84SS6
AFLT86	7.02 x 8.25/178 x 210	AVK86	AVK86SS6
AFLT88	9.39 x 8.25/239 x 210	AVK88	AVK88SS6
AFLT812	14.14 x 8.25/359 x 210	AVK812	AVK812SS6

VENT KIT

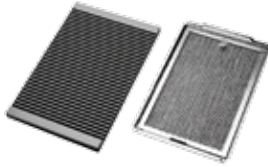

Includes a stylized louvered cover and filter package. Use as an air inlet when a cooling fan is mounted in an enclosure or use two vent kits to allow passive airflow. Mounting hardware included. Vent Kit requires cutout shown in diagram. Available in gray (RAL 7042) or black.

CATALOG NUMBERS		
	XPV32	PPV32B
UNIT CONSTRUCTION		
Dimension H x W x D (in./mm)	11.81 x 7.88 x 1.03 300 x 200 x 26	11.81 x 7.88 x 1.03 300 x 200 x 26
Color	Gray	Black

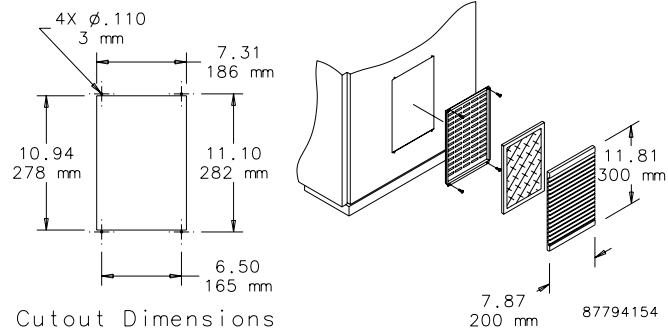

VENTILATOR



Designed to fit most metallic and non-metallic enclosures. Proper installation will provide rainproof ventilation but will not meet Type 4 or 12 requirements. Kit includes mounting hardware, and instructions. Supplied screws are 13-mm (.515-inch) long. Some applications may require longer screws.

CATALOG NUMBERS		
	ANMV6	ANMV3
DESIGN DATA		
Description	Large nonmetallic vent	Small nonmetallic vent

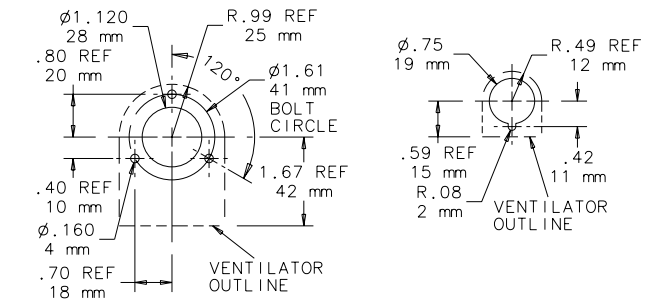

Large Ventilator

Small Ventilator

87541390

FILTER ADHESIVE



Designed to maximize the efficiency of all expanded aluminum air filters. Use of Filter Adhesive doubles the dust-retention capacity of the filter. Adhesive contains a low-viscosity water-soluble oil which absorbs dirt particles trapped on the surface of the filter. Through the circulation of the oil, a renewed impurity-absorbing surface is constantly established. Washing with water will remove dust, dirt and other impurities. Once the filter is dry, recoat with adhesive.

CATALOG NUMBERS	
	AFLTAD
DESIGN DATA	
Description	Spray Adhesive