



FieldServer – EZ Gateway
Modbus to BACnet Start-up Guide
FS-EZX-MOD-BAC



APPLICABILITY & EFFECTIVITY

Effective for all systems manufactured after June 2019.

Document Revision: 1.E
T18626

Technical Support

Please call us for any technical support needs related to the FieldServer product.

Sierra Monitor Corporation
1991 Tarob Court
Milpitas, CA 95035

Website: www.sierramonitor.com

U.S. Support Information:

+1 408 964-4443

+1 800 727-4377

Email: support@sierramonitor.com

EMEA Support Information:

+31 33 808 0590

Email: support.emea@sierramonitor.com

TABLE OF CONTENTS

- 1 About the EZ Gateway.....6**
- 2 Certification.....6**
 - 2.1 BTL Mark – BACnet Testing Laboratory6
- 3 Supplied Equipment.....6**
- 4 Installing the EZ Gateway.....7**
 - 4.1 Mounting.....7
 - 4.2 DIP Switch Settings8
 - 4.2.1 Bias Resistors8
 - 4.2.2 Termination Resistor9
 - 4.3 Connecting the R1 Port10
 - 4.3.1 Wiring10
 - 4.3.2 Supported RS-485 Baud Rates by Protocol10
 - 4.4 Power Up the Device.....11
- 5 Connect the PC to the EZ Gateway.....12**
 - 5.1 Connecting to the Gateway via Ethernet.....12
 - 5.1.1 Enable Access Through the Local Browser12
 - 5.1.1.1 Changing the Subnet of the Connected PC.....12
 - 5.1.1.2 Changing the IP Address of the EZ Gateway with FieldServer Toolbox13
 - 5.2 Using Web Configurator GUI.....14
 - 5.2.1 Controls, Status and Log Functions14
 - 5.2.2 Accessing SMC Cloud14
- 6 Configuring the EZ Gateway15**
 - 6.1 Setting up the Connections15
 - 6.2 Creating Device EZ Profiles16
 - 6.2.1 Using the Device Web Interface to Map BACnet Objects.....17
 - 6.2.2 Using Excel Profile Generator to Map BACnet Objects19
 - 6.2.3 Completing Device Profile Setup20
 - 6.2.4 Export Profile for Backup or Future Use21
 - 6.3 Importing a Device Profile22
 - 6.4 Mapping BACnet Output with Device EZ Profiles23
 - 6.5 Test and Commission the EZ Gateway.....24
- 7 Using the Embedded BACnet Explorer25**
 - 7.1 Discover Device List.....26
 - 7.2 View Device Details and Explore Points/Parameters.....27
 - 7.2.1 Edit the Present Value Field.....30
- 8 Connecting to the SMC Cloud.....32**
 - 8.1 Create a New SMC Cloud Account32
 - 8.2 Registration Process37
 - 8.3 Login to SMC Cloud39
- Appendix A Troubleshooting.....41**
 - Appendix A.1. Communicating with the EZ Gateway Over the Network41
 - Appendix A.2. Notes Regarding Subnets and Subnet Masks.....41
 - Appendix A.3. Before Contacting Technical Support Take a Diagnostic Capture42
 - Appendix A.3.1. Using the FieldServer Toolbox.....42
 - Appendix A.3.2. Using FS-GUI.....45
 - Appendix A.4. LED Functions46
 - Appendix A.5. Factory Reset Instructions46
 - Appendix A.6. Internet Browsers Not Supported46

Appendix B Reference	47
Appendix B.1. Specifications.....	47
Appendix B.2. Compliance with UL Regulations.....	48
Appendix B.3. Dimension Drawing FS-EZX-MOD-BAC	48
Appendix B.4. Address Types and Data Types	49
Appendix C Limited 2 Year Warranty	50

LIST OF FIGURES

Figure 1: DIN Rail Bracket 7

Figure 2: DIN Rail Mounted 7

Figure 3: Bias Resistor DIP Switches 8

Figure 4: Termination Resistor DIP Switch 9

Figure 5: R1 & R2 Connection Ports 10

Figure 6: Required Current Draw for the Gateway 11

Figure 7: Power Connections 11

Figure 8: Ethernet Port Location 12

Figure 9: EZ Gateway Landing Page 14

Figure 10: Connections Page 15

Figure 11: Device Profiles Page 16

Figure 12: Edit Profile Window 17

Figure 13: Data Map Window 17

Figure 14: Mapping BACnet Addresses to Modbus Registers 18

Figure 15: Save Button 18

Figure 16: Profile Generator Excel Spreadsheet 19

Figure 17: Device Settings Window 20

Figure 18: State Table Window 20

Figure 19: Notification Class Window 21

Figure 20: Save Button 21

Figure 21: Export Profile 21

Figure 22: Importing a Device Profile 22

Figure 23: Choose Profile to Load 23

Figure 24: Controls Section 23

Figure 25: FS-GUI Connections Screen 24

Figure 26: BACnet Explorer Tab 25

Figure 27: BACnet Explorer Login Page 25

Figure 28: BACnet Explorer Page 26

Figure 29: Discover Window 26

Figure 30: Device List 27

Figure 31: Device Sub-items 27

Figure 32: Full Device Sub-items 28

Figure 33: Simplified Device Details 28

Figure 34: Additional Device Details 29

Figure 35: Highlighted Present Value 30

Figure 36: Write Property Window 30

Figure 37: Updated Present Value 31

Figure 38: Web App Landing Page – FieldPoP Tab 32

Figure 39: Registration Information Page 32

Figure 40: SMC Cloud Connection Problems Message 33

Figure 41: SMC Cloud Registration Page 34

Figure 42: Welcome to SMC Cloud Email 35

Figure 43: Setting User Details 36

Figure 44: Register the Gateway on the SMC Cloud 37

Figure 45: Device Registered for SMC Cloud 38

Figure 46: SMC Cloud Login Page 39

Figure 47: SMC Cloud Privacy Policy 39

Figure 48: SMC Cloud Landing Page 40

Figure 49: Ethernet Port Location 42

Figure 50: Diagnostic LEDs 46

Figure 51: Specifications 47

Figure 52: EZ Gateway Dimension Drawing 48

1 ABOUT THE EZ GATEWAY

EZ Gateway is a high performance, cost effective building and industrial automation multi-protocol gateway providing protocol translation between serial and Ethernet, devices and networks.

NOTE: For troubleshooting assistance refer to [Appendix A](#), or any of the troubleshooting appendices in the related driver supplements. Check the [Sierra Monitor website](#) for technical support resources and documentation that may be of assistance.

The EZ Gateway is cloud ready and connects with Sierra Monitor’s SMC Cloud. See [Section 5.2.2](#) for further information.

2 CERTIFICATION

2.1 BTL Mark – BACnet Testing Laboratory¹



The BTL Mark on EZ Gateway is a symbol that indicates that a product has passed a series of rigorous tests conducted by an independent laboratory which verifies that the product correctly implements the BACnet features claimed in the listing. The mark is a symbol of a high-quality BACnet product.

Go to www.BACnetInternational.net for more information about the BACnet Testing Laboratory. Click [here](#) for the BACnet PIC Statement.

3 SUPPLIED EQUIPMENT

EZ Gateway

- Preloaded with the Modbus and BACnet drivers.
- All instruction manuals, driver manuals, support utilities are available on the USB drive provided in the optional accessory kit, or on the [Sierra Monitor website](#).

Accessory kit (optional) (Part # FS-8915-38-QS) includes:

- 7-ft Cat-5 cable with RJ45 connectors at both ends
- Power Supply -110/220V (p/n 69196)
- Screwdriver for connecting to terminals
- USB Flash drive loaded with:
 - Modbus to BACnet Start-up Guide
 - FieldServer Configuration Manual
 - All FieldServer Driver Manuals
 - Support Utilities
 - Any additional folders related to special files configured for a specific EZ Gateway
 - Additional components as required - see driver manual supplement for details



¹ BACnet is a registered trademark of ASHRAE.

4 INSTALLING THE EZ GATEWAY

4.1 Mounting

The EZ Gateway can be mounted using the DIN rail mounting bracket on the back of the unit.

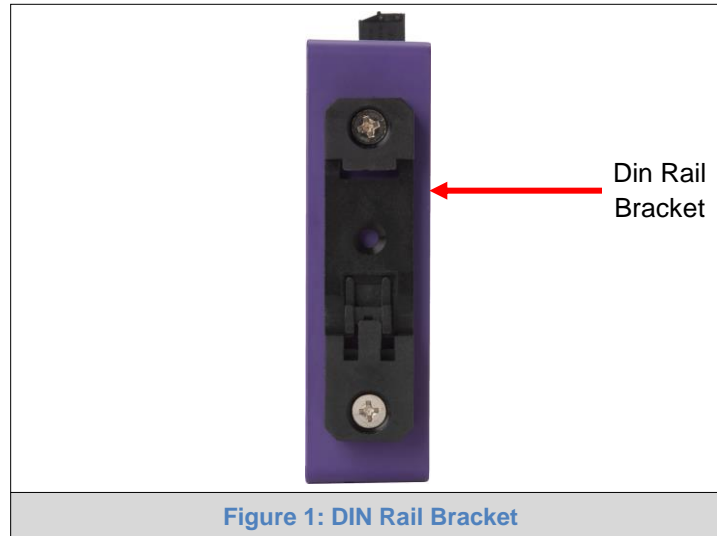

Figure 1: DIN Rail Bracket

NOTE: For dimension details see [Appendix B.3](#).



Figure 2: DIN Rail Mounted

4.2 DIP Switch Settings

4.2.1 Bias Resistors

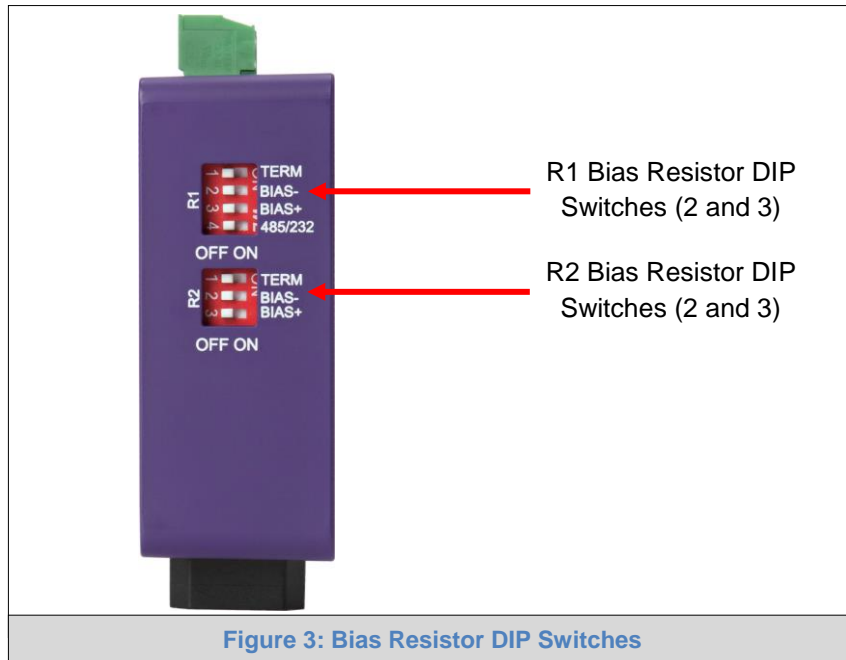

To enable Bias Resistors, move both the BIAS- and BIAS+ dip switches to the right in the orientation shown in [Figure 3](#).

The EZ Gateway bias resistors are used to keep the RS-485 bus to a known state, when there is no transmission on the line (bus is idling), to help prevent false bits of data from being detected. The bias resistors typically pull one line high and the other low - far away from the decision point of the logic.

The bias resistor is 510 ohms which is in line with the BACnet spec. It should only be enabled at one point on the bus (for example, on the field port were there are very weak bias resistors of 100k). Since there are no jumpers, many EZ Gateways can be put on the network without running into the bias resistor limit which is < 500 ohms.

NOTE: See www.ni.com/support/serial/resinfo.htm for additional pictures and notes.

NOTE: The R1 and R2 DIP Switches apply settings to the respective serial port.

NOTE: If the gateway is already powered on, DIP switch settings will not take effect unless the unit is power cycled.

4.2.2 Termination Resistor

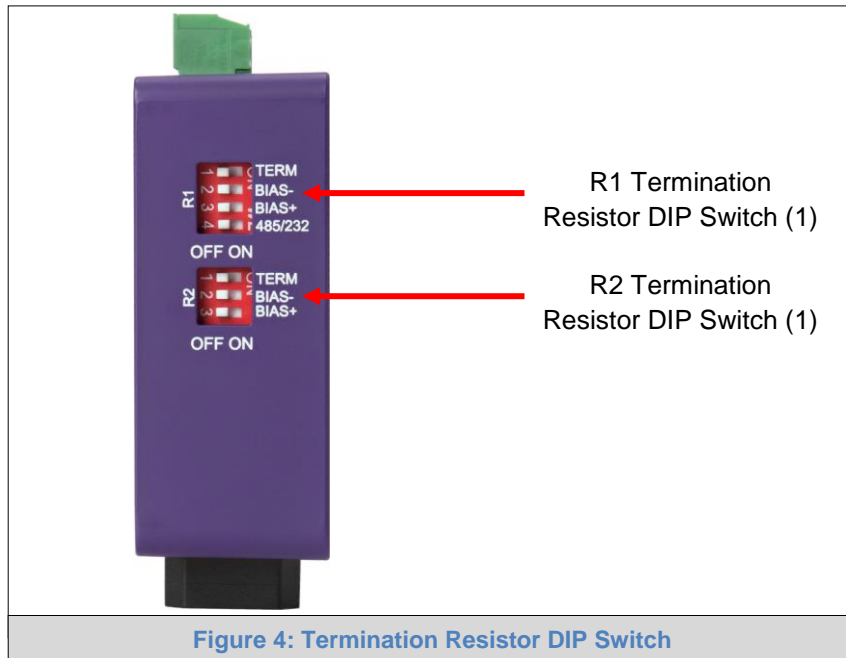

If the EZ Gateway is the last device on the serial trunk, then the End-Of-Line Termination Switch needs to be enabled. **To enable the Termination Resistor, move the TERM dip switch to the right in the orientation shown in Figure 4.**

Termination resistor is also used to reduce noise. It pulls the two lines of an idle bus together. However, the resistor would override the effect of any bias resistors if connected.

NOTE: The R1 and R2 DIP Switches apply settings to the respective serial port.

NOTE: If the gateway is already powered on, DIP switch settings will not take effect unless the unit is power cycled.

4.3 Connecting the R1 Port

For the R1 Port only: Switch between RS-485 and RS-232 by moving the number 4 DIP Switch left for RS-485 and right for RS-232 (**Figure 4**).

The R2 Port is RS-485.

Connect to the 3-pin connector(s) as shown below.

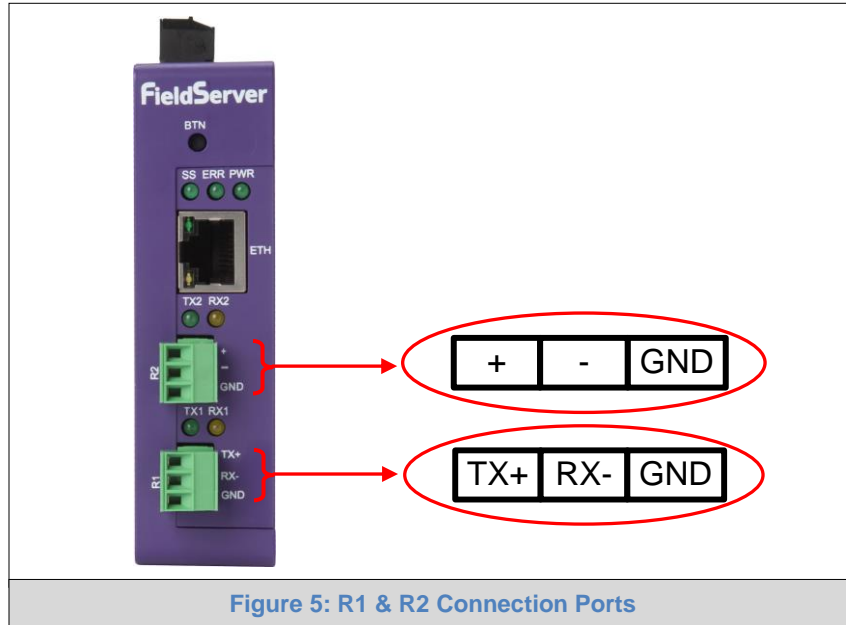

Figure 5: R1 & R2 Connection Ports

4.3.1 Wiring

RS-485		RS-232	
BMS RS-485 Wiring	Gateway Pin Assignment	BMS RS-232 Wiring	Gateway Pin Assignment
RS-485 +	TX +	RS-232 -	TX +
RS-485 -	RX -	RS-232 +	RX -
GND	GND	GND	GND

NOTE: Use standard grounding principles for GND.

4.3.2 Supported RS-485 Baud Rates by Protocol

The supported baud rates for either port is based on the protocol of the connected devices.

The following baud rates are supported for Modbus RTU:

2400, 4800, 9600, 19200, 38400, 57600, 76800, 115200

The following baud rates are supported for BACnet MS/TP:

9600, 19200, 38400, 76800

4.4 Power Up the Device

Check power requirements in the table below:

Power Requirement for External Gateway		
	Current Draw Type	
EZ Gateway Family	12VDC	24V DC/AC
FS-EZ3-MOD-BAC (Typical)	250mA	125mA
FS-EZ4-MOD-BAC (Typical)	250mA	125mA
NOTE: These values are 'nominal' and a safety margin should be added to the power supply of the host system. A safety margin of 25% is recommended.		
Figure 6: Required Current Draw for the Gateway		

Apply power to the EZ Gateway as shown below in **Figure 7**. Ensure that the power supply used complies with the specifications provided in **Appendix B.1**.

- The gateway accepts 12-24VDC or 24VAC on pins L+ and N-.
- **Frame GND should be connected.**

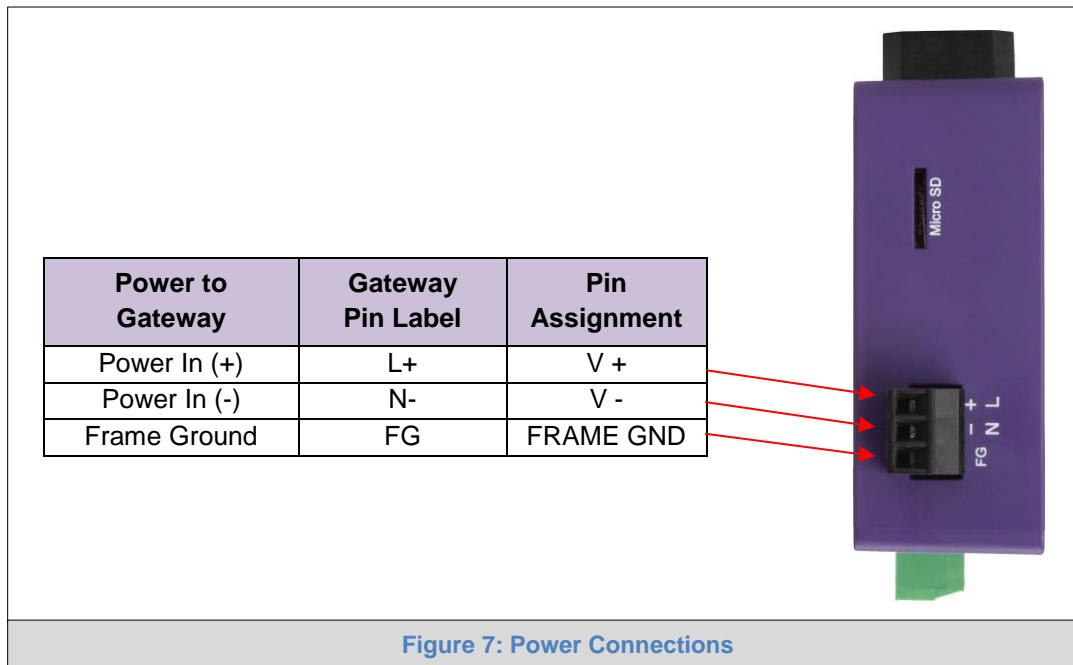

5 CONNECT THE PC TO THE EZ GATEWAY

5.1 Connecting to the Gateway via Ethernet

First, connect a Cat-5 Ethernet cable (straight through or cross-over) between the local PC and the EZ Gateway.

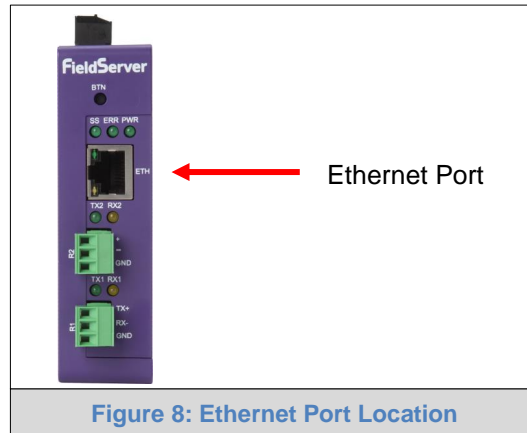

Figure 8: Ethernet Port Location

5.1.1 Enable Access Through the Local Browser



There are two methods to enable access to the EZ Gateway in the local browser, either by changing the subnet of the connected PC (Section 5.1.1.1) or using the FieldServer Toolbox to change the IP Address of the EZ Gateway (Section 5.1.1.2).

NOTE: Only perform one method or the other.

5.1.1.1 Changing the Subnet of the Connected PC

The default IP Address for the EZ Gateway is **192.168.2.101**, Subnet Mask is **255.255.255.0**. If the PC and EZ Gateway are on different IP networks, assign a static IP Address to the PC on the 192.168.1.xxx network.

For Windows 10:

- Find the search field in the local computer’s taskbar (usually to the right of the windows icon ) and type in “Control Panel”.
- Click “Control Panel”, click “Network and Internet” and then click “Network and Sharing Center”.
- Click “Change adapter settings” on the left side of the window.
- Right-click on “Local Area Connection” and select “Properties” from the dropdown menu.
- Highlight  **Internet Protocol Version 4 (TCP/IPv4)** and then click the Properties button.
- Select and enter a static IP Address on the same subnet. For example:

Use the following IP address:

IP address:	192 . 168 . 1 . 11
Subnet mask:	255 . 255 . 255 . 0
Default gateway:	. . .

- Click the Okay button to close the Internet Protocol window and the Close button to close the Ethernet Properties window.

5.1.1.2 Changing the IP Address of the EZ Gateway with FieldServer Toolbox

- Ensure that FieldServer Toolbox is loaded onto the local PC. Otherwise, download the FieldServer-Toolbox.zip via the Sierra Monitor website’s [Software Downloads](#).
- Extract the executable file and complete the installation.
- Double click on the FS Toolbox Utility and click Discover Now on the splash page.
- Find the desired gateway and click the Configure Device button (gear icon) to the right of the gateway information.

NOTE: If connectivity status is green, then the IP Address doesn’t need to be changed (the EZ Gateway is already on the same subnet). Skip the rest of the section and go to Section 5.2.

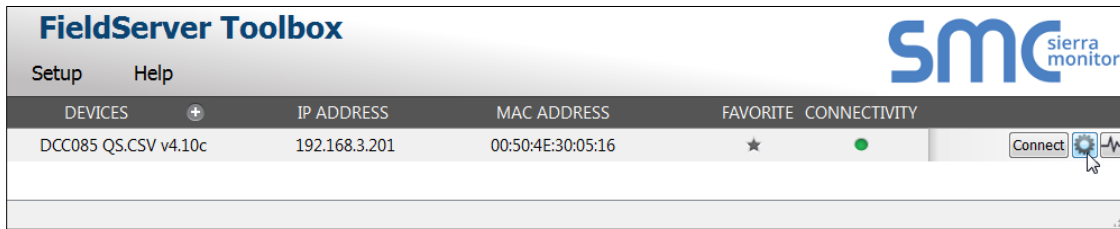

- Select Network Settings in the Configure Device window.

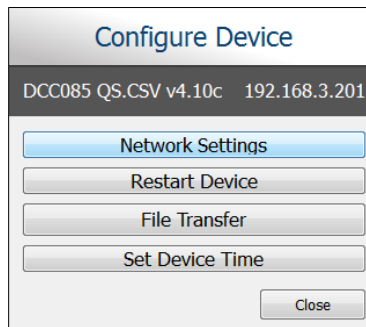

- Modify the IP Address (N1 IP Address field) of the gateway Ethernet port.
 - Change additional fields as needed

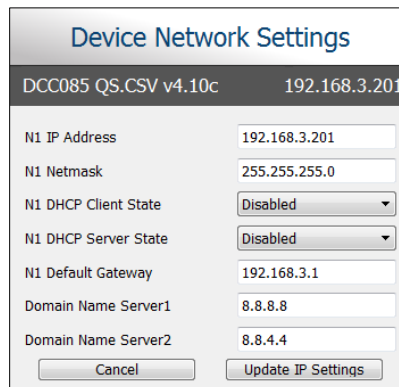

NOTE: If the gateway is connected to a router, the Default Gateway field of the gateway should be set to the IP Address of the connected router.

NOTE: Do not change the DHCP Server State (N1 DHCP Server State field).

NOTE: If DNS settings are unknown, set DNS1 to “8.8.8.8” and DNS2 to “8.8.4.4”.

- Click Update IP Settings, then click the “Change and restart” button to reboot the Gateway and activate the new IP Address. See the [FieldServer Toolbox and GUI Manual](#) for more information.

5.2 Using Web Configurator GUI

- Open a web browser and connect to the EZ Gateway's default IP Address. The default IP Address of the FieldServer is **192.168.2.101**, Subnet Mask is **255.255.255.0**.
- If the PC and the EZ Gateway are on different IP networks, assign a static IP Address to the PC on the 192.168.2.X network.

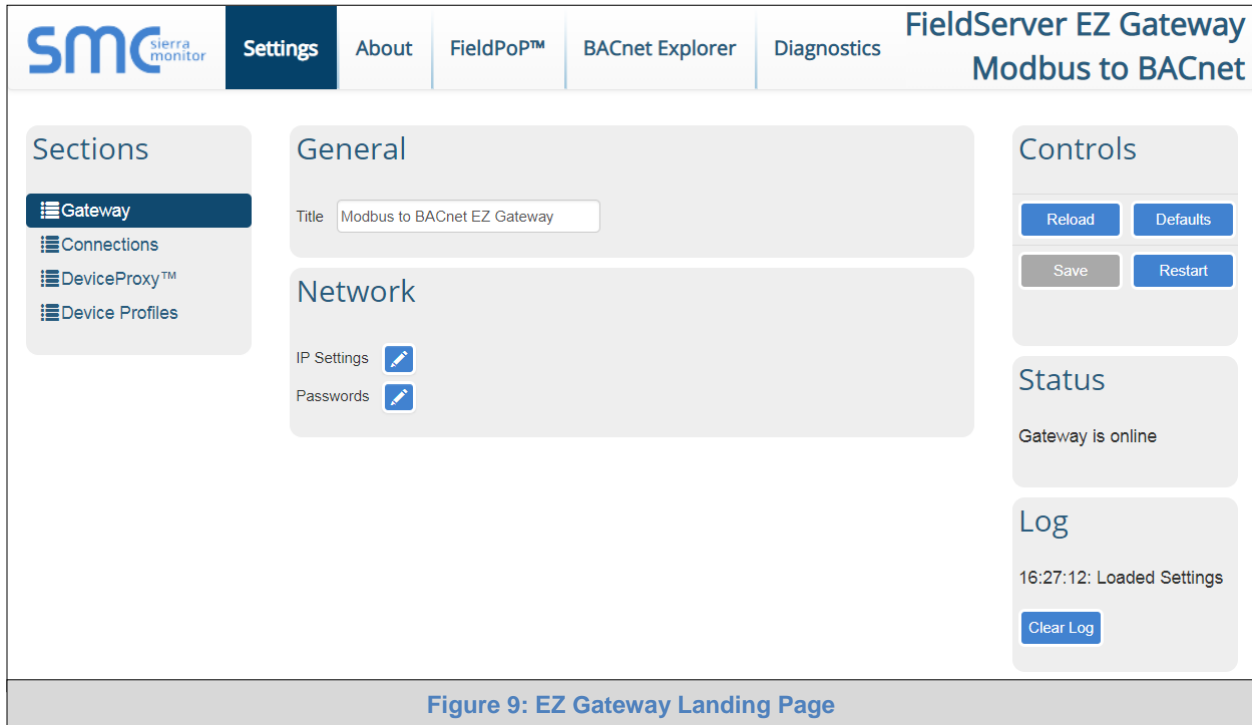

Figure 9: EZ Gateway Landing Page

5.2.1 Controls, Status and Log Functions

Along the right side of every Web Configurator GUI page is a column of buttons and event generated messages.

- **Controls Panel** – Contains the following four buttons:
 - *Reload* – Resets all settings to the last saved configuration
 - *Defaults* – Resets all settings to the default configuration
 - *Save* – Records all settings
 - *Restart* – Reboots the Gateway
- **Status Information** – Shows Gateway messages such as whether the Gateway is online, element validation status, unsaved settings, etc.
- **Log Messages** – Lists last five events and when they were performed.

5.2.2 Accessing SMC Cloud

The FieldPoP™ tab [FieldPoP™](#) (see [Figure 9](#)) allows users to connect to the SMC Cloud, Sierra Monitor's device cloud solution for IIoT. The SMC Cloud enables secure remote connection to field devices through a FieldServer and its local applications for configuration, management, maintenance. For more information about the SMC Cloud, refer to the [SMC Cloud Start-up Guide](#).

6 CONFIGURING THE EZ GATEWAY

6.1 Setting up the Connections

- Open the Connections page to configure the connection ports and parameters.

The screenshot displays the 'Connections' page in the FieldServer EZ Gateway Modbus to BACnet interface. The page is organized into several sections:

- Sections:** A sidebar on the left contains links for Gateway, Connections (selected), DeviceProxy™, and Device Profiles.
- Modbus RTU R1:** Includes fields for Enable (checked), Port (R1), Baud Rate (9600), Parity (None), Data Bits (8), Stop Bits (1), and Poll Delay (0.1).
- Modbus RTU R2:** Includes fields for Enable (unchecked), Port (R2), Baud Rate (9600), Parity (None), Data Bits (8), Stop Bits (1), and Poll Delay (0.1).
- Modbus TCP:** Includes fields for Enable (checked), Poll Delay (0.1), and Max Concurrent Messages (1).
- BACnet IP:** Includes fields for Enable (checked), IP Port (47808), Enable BBMD (unchecked), Public IP Address, Public IP Port, and Broadcast Distribution Table (checked).
- BACnet IP Settings:** Includes fields for Virtual Network Number (1100), Internal Network Number 1 (1200), and Internal Network Number 2 (1201).
- BACnet MSTP Settings:** Includes fields for Virtual Network Number (1101), Internal Network Number 1 (1202), and Internal Network Number 2 (1203).
- BACnet MSTP R1:** Includes fields for Enable (unchecked), Baud Rate (38400), Parity (None), Data Bits (8), Stop Bits (1), Mode (Master), Max Master (127), Max Info Frames (1), and MAC Address (1).
- BACnet MSTP R2:** Includes fields for Enable (checked), Baud Rate (38400), Parity (None), Data Bits (8), Stop Bits (1), Mode (Master), Max Master (127), Max Info Frames (1), and MAC Address (2).
- Controls:** Contains buttons for Reload, Defaults, Save, and Restart.
- Status:** Shows 'Gateway is online'.
- Log:** Shows '16:27:12: Loaded Settings' and a Clear Log button.

Figure 10: Connections Page

- Click the Save button in the Controls section once completed.
- Then click Restart to implement the new settings.

6.2 Creating Device EZ Profiles

- Open the Device Profiles page to create a new profile.

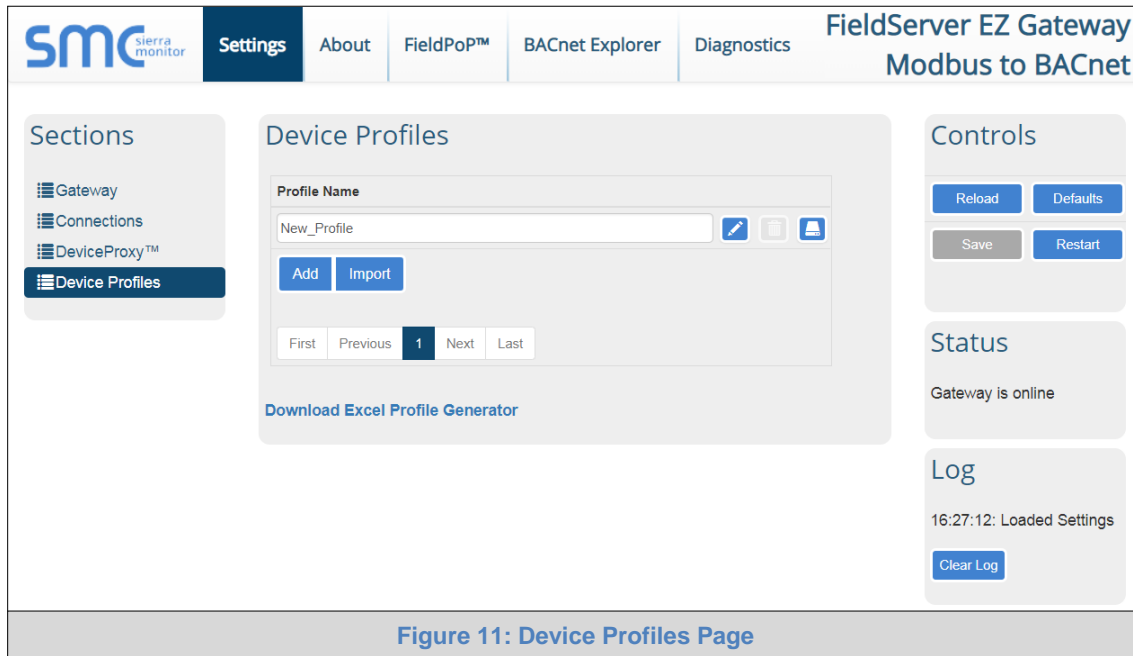

Figure 11: Device Profiles Page

- Create a data map using one of two methods:
 - Create Modbus to BACnet mapping using the Web Interface (**Section 6.2.1**)
 - Create Modbus to BACnet mapping using Excel Profile Generator (**Section 6.2.2**)
- After saving the data map, complete the profile setup by updating State Tables and Notification Classes as needed. (**Section 6.2.3**)

6.2.1 Using the Device Web Interface to Map BACnet Objects

NOTE: The Add button creates another blank profile that must be mapped using the Web Interface.

- Click on the Edit button (pencil icon) next to the name of the profile to map.
- Enter the Modbus and BACnet parameters.

NOTE: See for [Appendix B.4](#) additional information on Address Type.

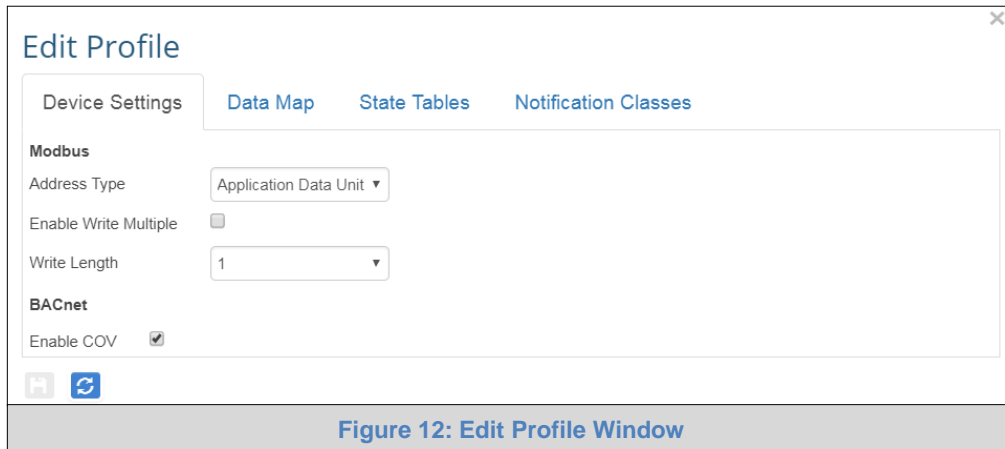

Figure 12: Edit Profile Window

- Click on the Data Map tab and add the first Modbus address range.

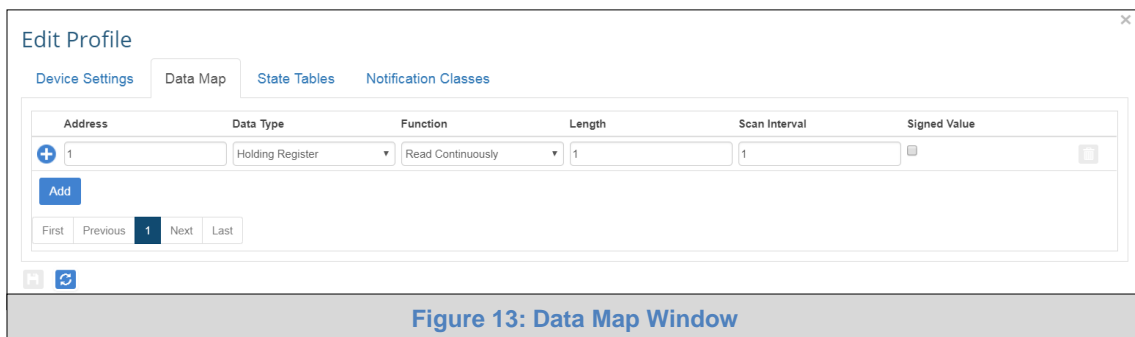

Figure 13: Data Map Window

NOTE: Check the Signed Value checkbox (right of the data map entry) if signed values are needed.

- Click on the blue plus sign icon on the left side of the Address to map the BACnet Addresses to the Modbus Registers.

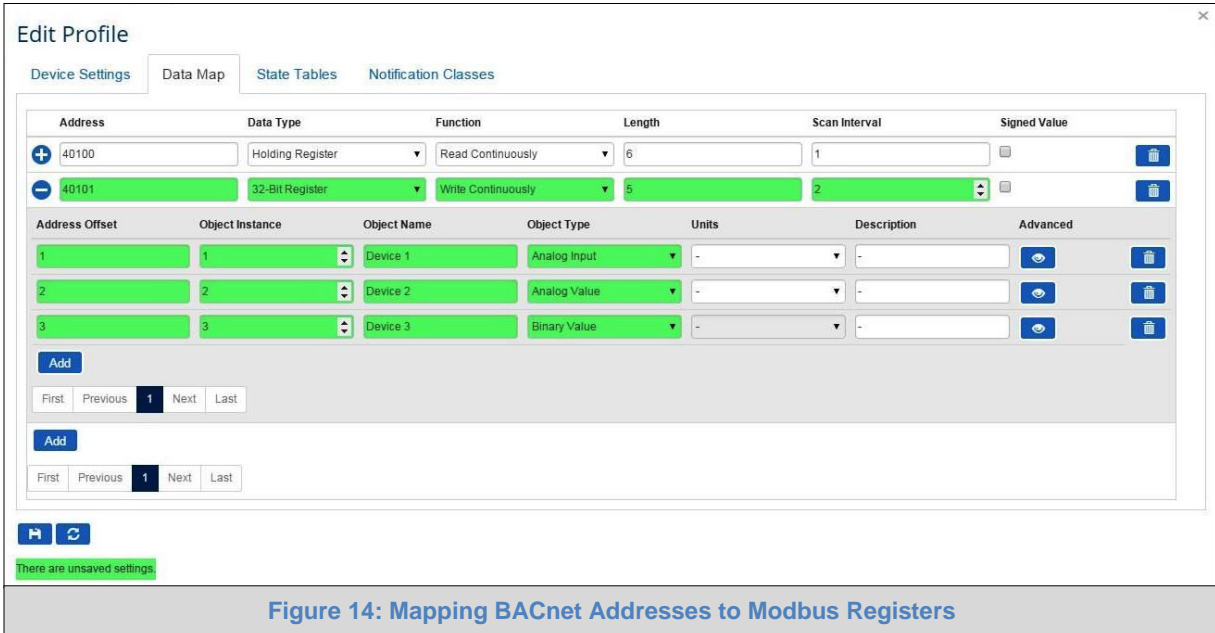

Figure 14: Mapping BACnet Addresses to Modbus Registers

NOTE: The Advanced button (eye icon) allows additional settings, including: Intrinsic Reporting, Bit Extraction, scaling and more.

- Repeat for all of the Modbus registers.
- Once all mappings are defined, click the “Save” button in the bottom left corner of the window to record the Profile.

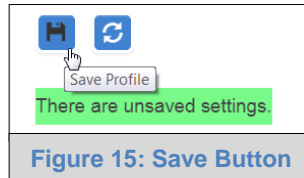

Figure 15: Save Button

6.2.2 Using Excel Profile Generator to Map BACnet Objects

- From the Device Profiles page ([Figure 11](#)), click on the “Download Excel Profile Generator” link to download the Excel spreadsheet used to create the profile to the default download folder on the local PC.
- Open the downloaded Excel spreadsheet and ensure that the content is not disabled by security settings (yellow security warning bar across the top of the spread sheet).

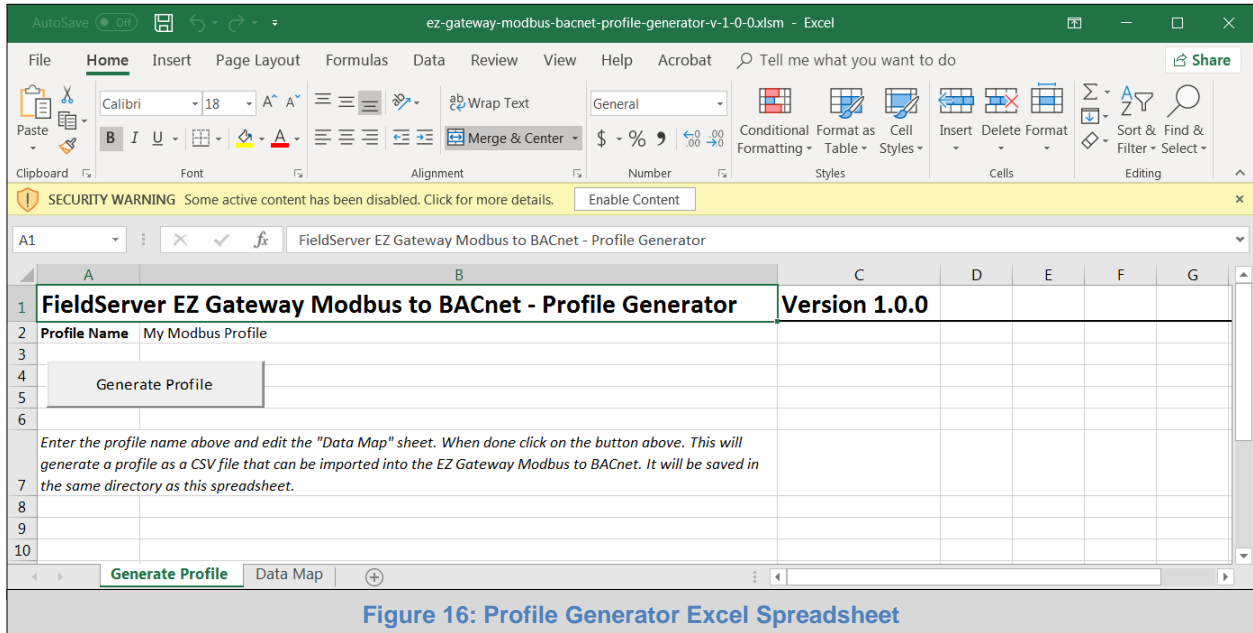

Figure 16: Profile Generator Excel Spreadsheet

NOTE: If the security warning is present simply click the **Enable Content** button found at the end of the warning.

- Click the Data Map tab (near the bottom of the Excel spreadsheet).
- Edit or copy in Modbus registers as needed.
- Once all the point mappings are complete, switch back to the Generate Profile tab.
- Click the Generate Profile button to create a new Excel .csv file titled “My Modbus Profile”.
- Go back to the EZ Gateway Device Profiles page ([Figure 11](#)) and click the Import button.
- Select the Excel .csv file and click the checkbox to load the mapping.
- Once all mappings are loaded, click Save in the Controls section.

6.2.3 Completing Device Profile Setup

- Click on the Edit button (pencil icon) next to the name of the profile to complete setup.
- If a data map was loaded from a file created from the “Excel Profile Generator”, go to the Device Settings tab to enter the Modbus and BACnet parameters.

NOTE: See for [Appendix B.4](#) additional information on Address Type.

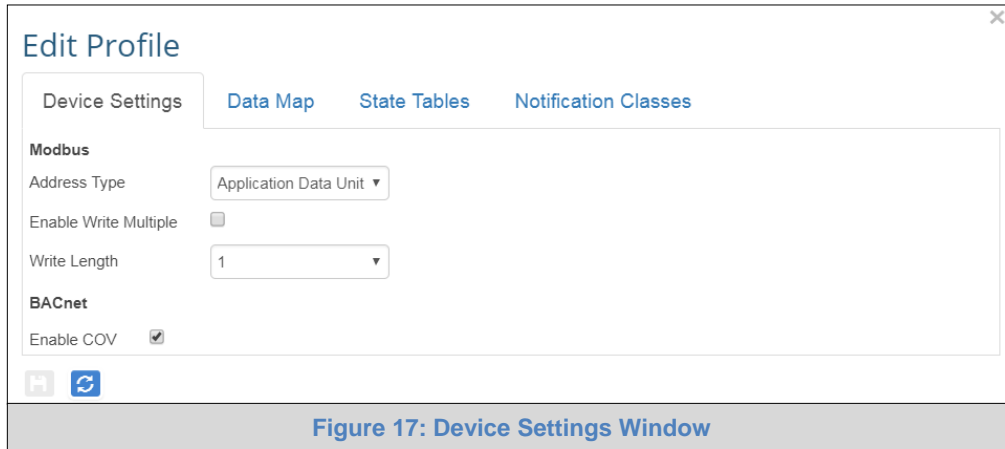

Figure 17: Device Settings Window

- If using a BACnet State Table, click on the “State Table” tab to define the table and its variables.

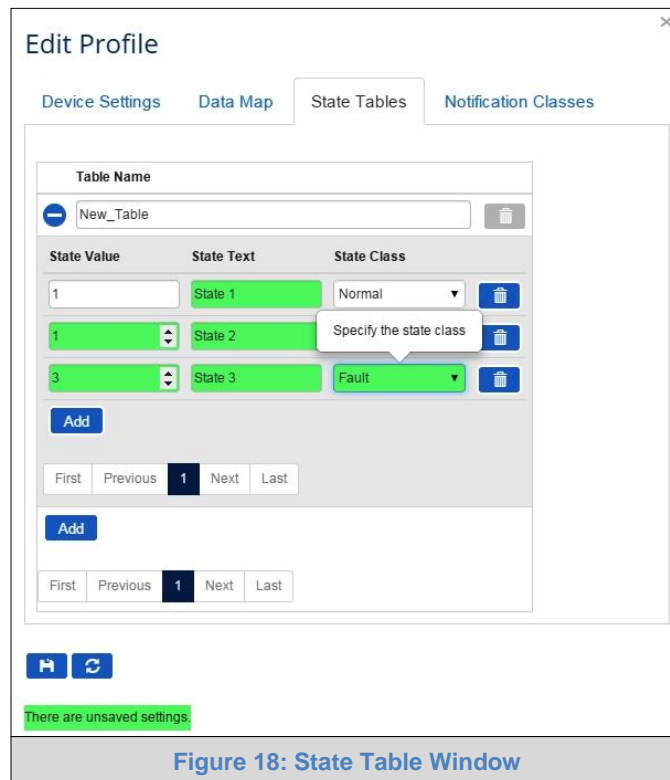

Figure 18: State Table Window

NOTE: The Table Name field must be 14 characters or less. No commas allowed.

NOTE: The State Text field must be 50 characters or less. No commas allowed.

- To define a Notification Class, click the “Notification Class” tab and define the parameters as needed.

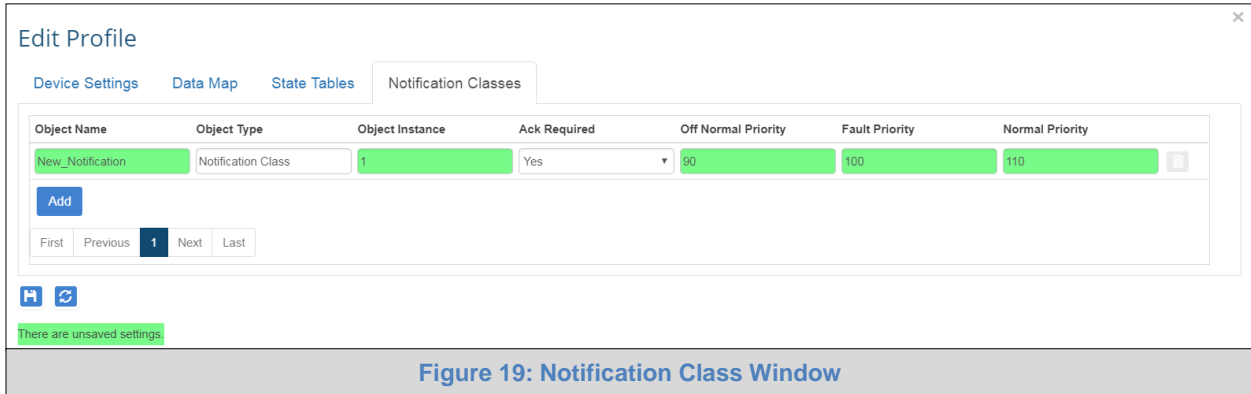

Figure 19: Notification Class Window

- Once all settings are defined, click the “Save” button in the bottom left corner of the window to record the Profile.

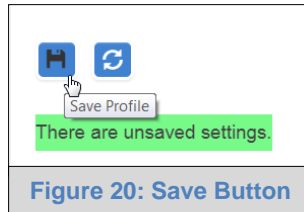

Figure 20: Save Button

6.2.4 Export Profile for Backup or Future Use

- Back on the Device Profiles page, the profile can be exported for backup or future use by hitting the Export Profile button (hard drive icon).

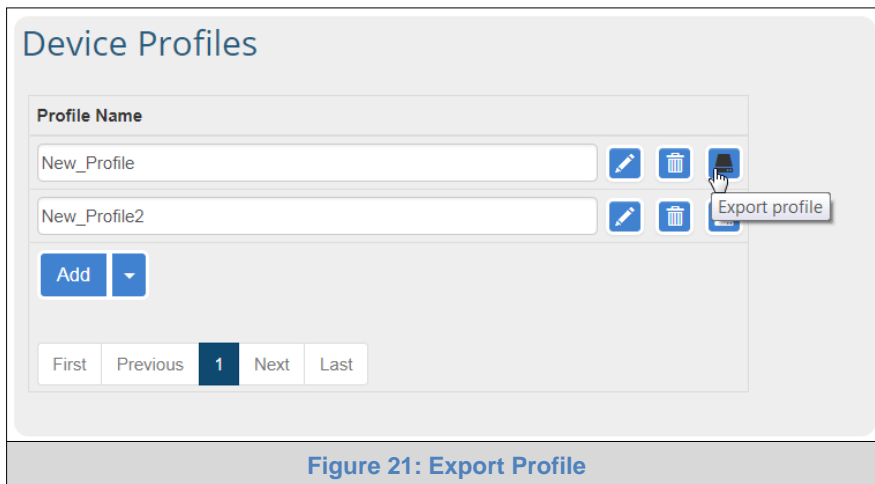

Figure 21: Export Profile

- The profile downloads to the local computer in the format: <Profile Name>.profile

6.3 Importing a Device Profile

- Profiles on the local computer can be imported to the EZ Gateway by going to the Device Profiles page and clicking the Import button.

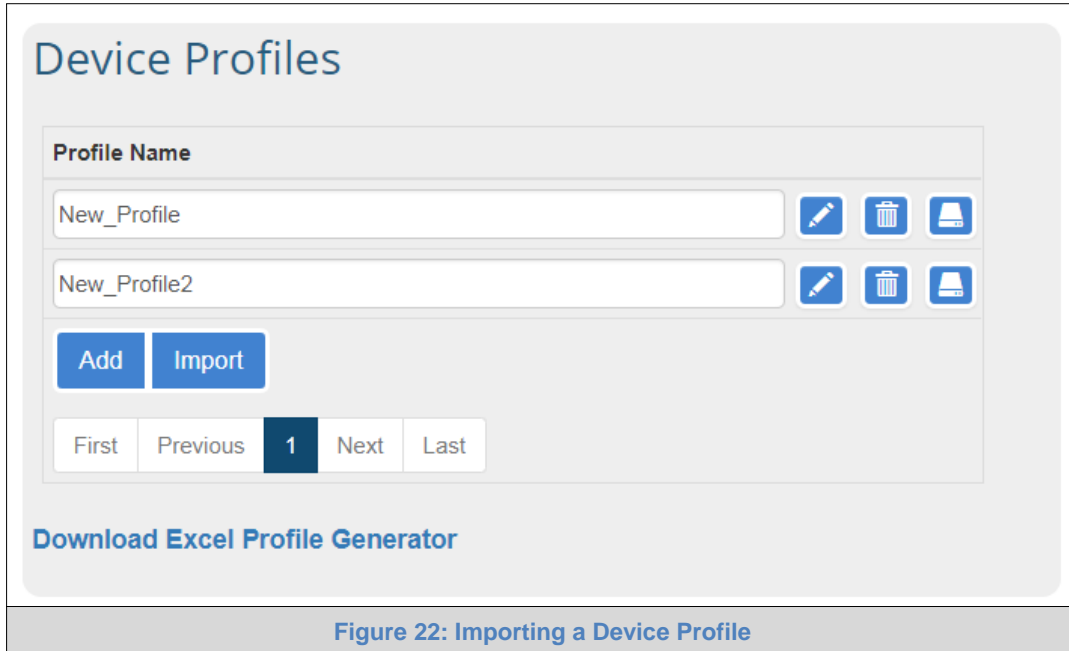

Figure 22: Importing a Device Profile

NOTE: All profiles will need to be created or imported to the EZ Gateway before proceeding.

NOTE: There are two types of files that can be imported. The Excel spreadsheet generated files (Section 6.2.2) or an exported profile (Section 6.2.4). Files generated from the downloaded “Excel Profile Generator” only include Data Map information and must be completed by going through the steps found in Section 6.2.3 after being loaded. However, exported profiles include complete profile information and can be used immediately after load up.

6.4 Mapping BACnet Output with Device EZ Profiles

- Open the DeviceProxy™ page.
- Choose the Device Profile to load from the drop down menu.

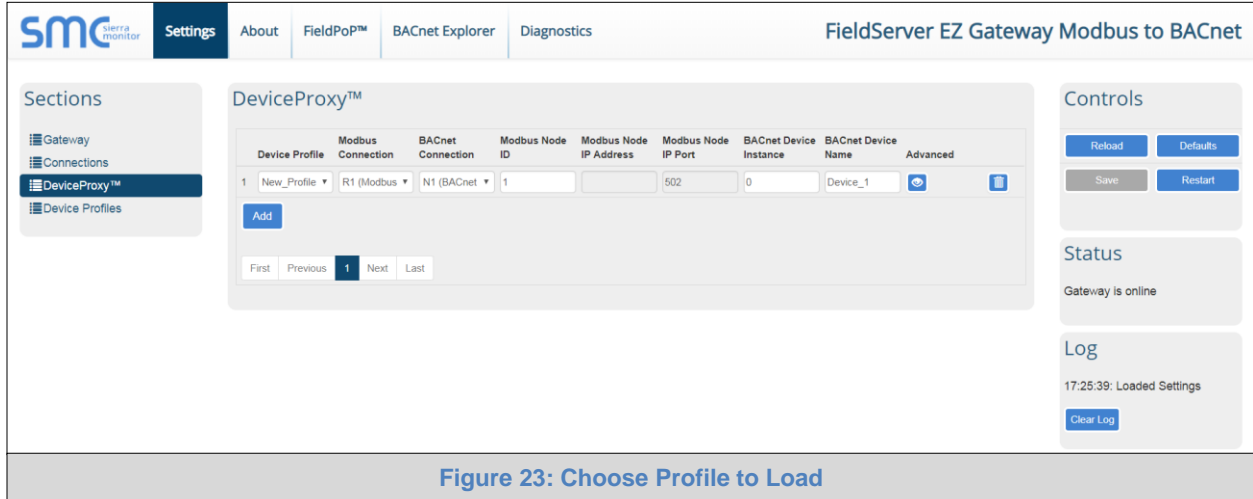
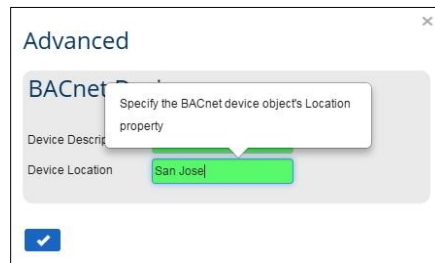

Figure 23: Choose Profile to Load

NOTE: If required, click the **Advanced Settings** button (eye icon) to enter the **Device Description** and **Device Location**.



- Choose the appropriate connection and Node ID/BACnet Device Instance for both the incoming Modbus device and the mapped BACnet output.
- Click Add to include additional device profiles in the Configuration.
- Repeat for all Modbus devices intended to connect to the EZ Gateway.
- Click the Save button in the Controls section once all device EZ Profiles are added and then click the Restart button to reset the system.

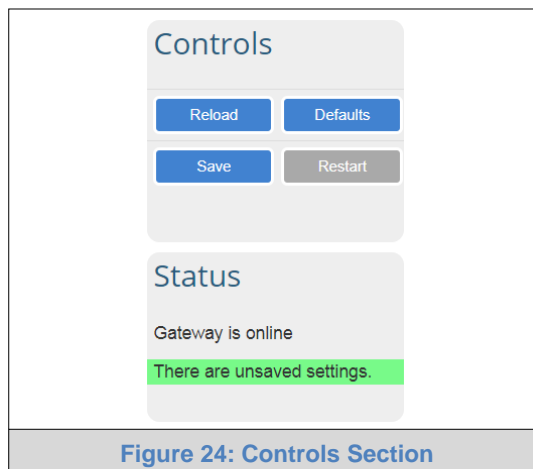

Figure 24: Controls Section

6.5 Test and Commission the EZ Gateway

- Connect the EZ Gateway to the third party device(s), and test the application.
- Click on the Diagnostic button to view to get to the FS-GUI.
- From the landing page of the FS-GUI click on View in the navigation tree, then Connections to see the number of messages on each protocol.

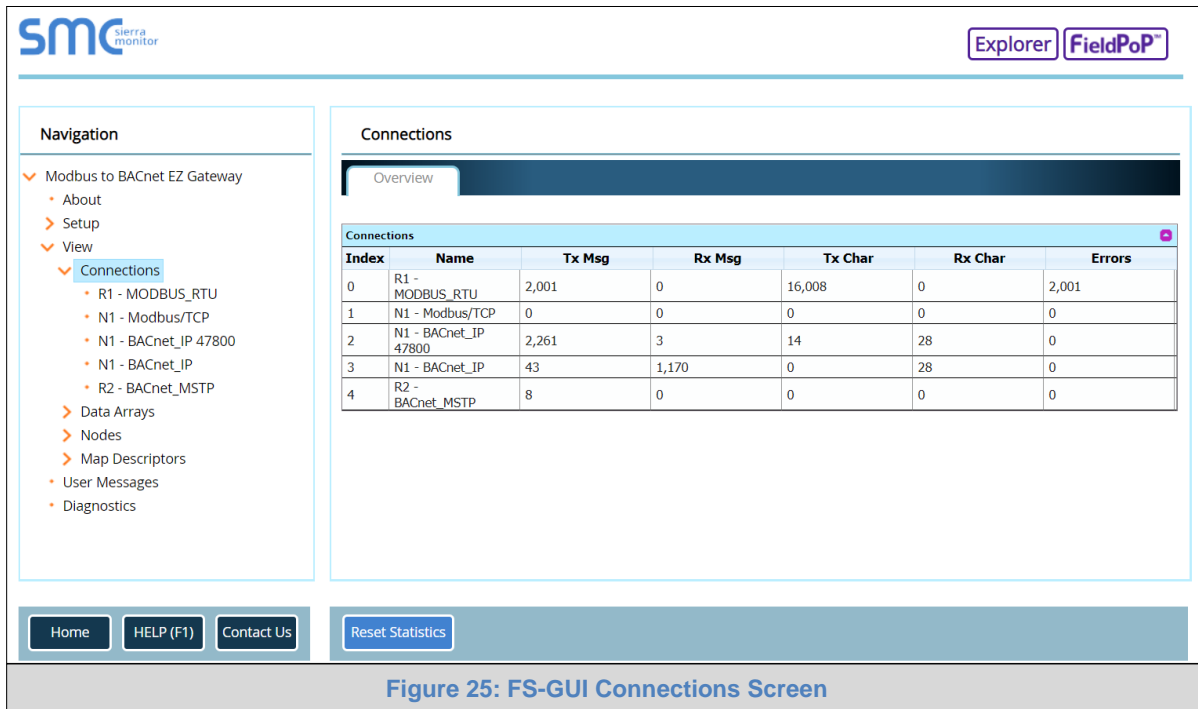



Figure 25: FS-GUI Connections Screen

NOTE: For troubleshooting assistance refer to [Appendix A](#), or any of the troubleshooting appendices in the related driver supplements and configuration manual. Sierra Monitor also offers a technical support on the [Sierra Monitor website](#), which contains a significant number of resources and documentation that may be of assistance.

NOTE: The FieldPoP™ button  (see [Figure 25](#)) allows users to connect to the SMC Cloud, Sierra Monitor’s device cloud solution for IIoT. The SMC Cloud enables secure remote connection to field devices through a FieldServer and its local applications for configuration, management, maintenance. For more information about the SMC Cloud, refer to the [SMC Cloud Start-up Guide](#).

7 USING THE EMBEDDED BACNET EXPLORER

The embedded BACnet Explorer allows installers of the product to validate that their equipment is working on BACnet without having to ask the BMS integrator to test the unit.

- To access the embedded BACnet Explorer, click the BACnet Explorer tab at the top of the screen.

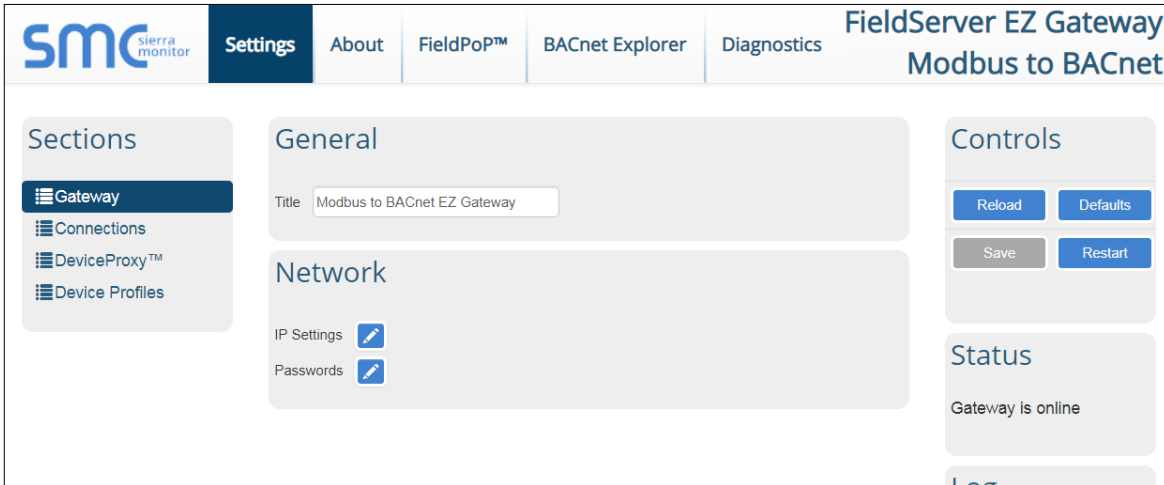

Figure 26: BACnet Explorer Tab

- Then login to the BACnet Explorer page using the supplied username and password.

NOTE: The default user name is “admin” and the default password is “admin”.

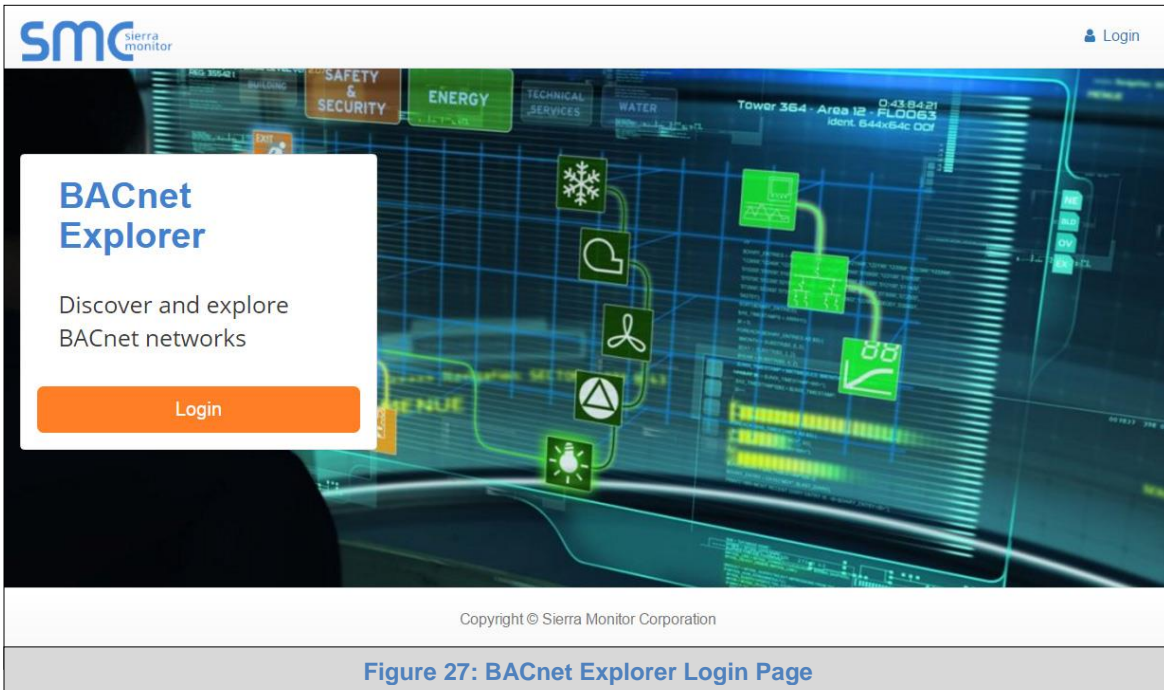

Figure 27: BACnet Explorer Login Page

NOTE: For BACnet/IP, click on the Connections page to ensure the EZ Gateway is on the BACnet/IP network subnet or to configure BBMD.

7.1 Discover Device List

- From the BACnet Explorer landing page, click on the BACnet Explorer button on the left side of the screen to go to the BACnet Explorer page.

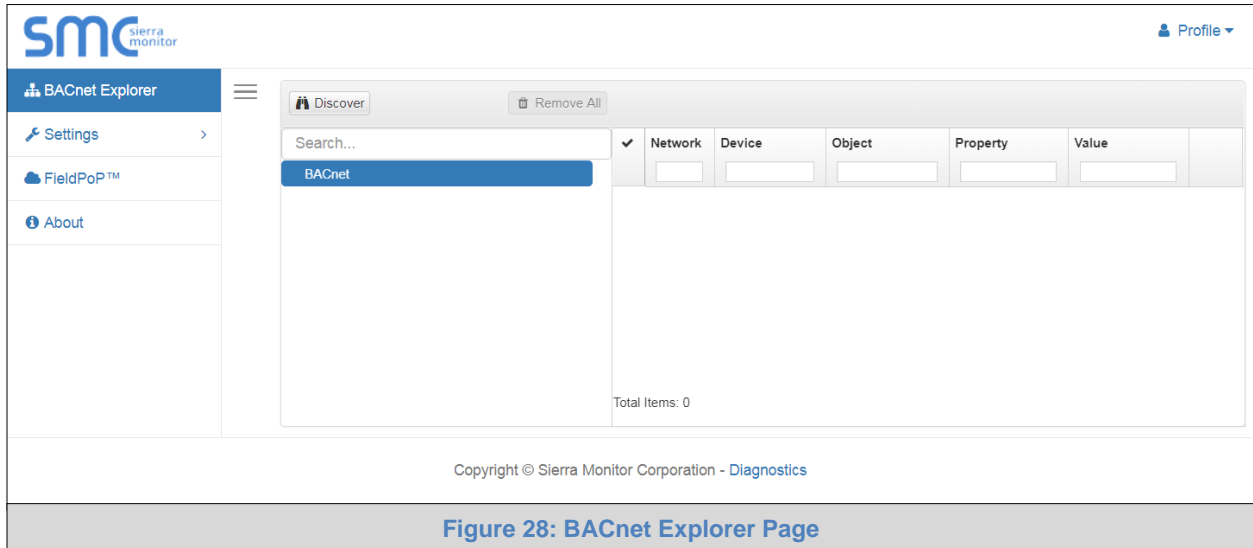

Figure 28: BACnet Explorer Page

- To discover the devices connected to the same subnet as the BACnet Explorer, click the Discover button (binocular icon).
- This will open the Discover window, click the checkboxes next to the desired search settings and click Discover to start the search.

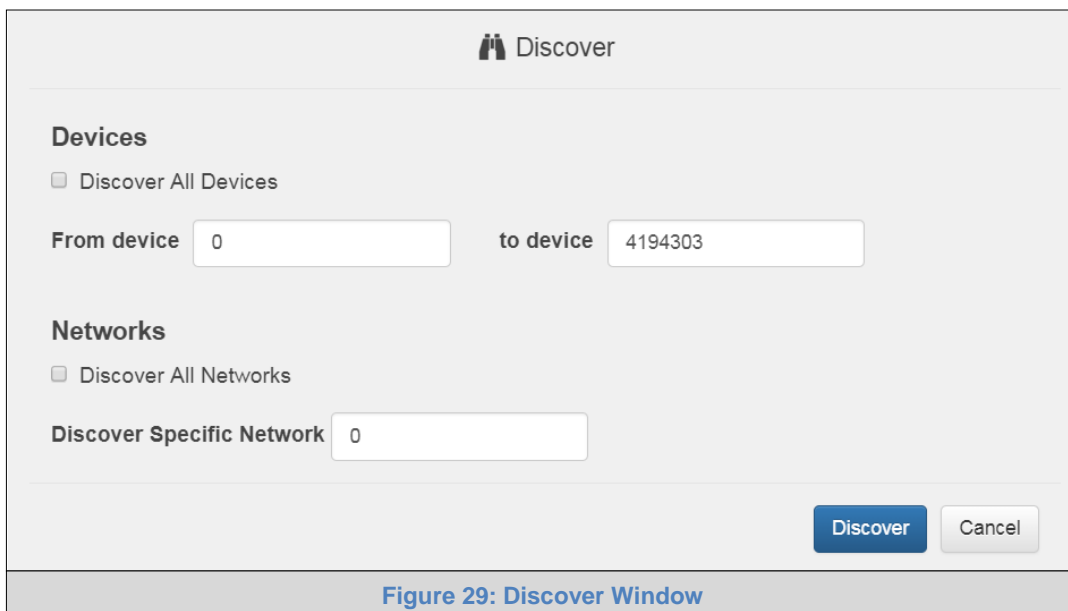

Figure 29: Discover Window

NOTE: The “Discover All Devices” or “Discover All Networks” checkboxes must be unchecked to search for a specific device range or network.

NOTE: Allow the devices to populate before interacting with the device list for optimal performance. Any discovery or explore process will cause a green message to appear in the upper right corner of the browser to confirm that the action is complete.

Device	Object	Property	Value	Monitor
1000 (BACnet Router)	device:1000 (BACnet Router)	max-apdu-length-accepted	1458	Off
1000 (BACnet Router)	device:1000 (BACnet Router)	object-name	BACnet Router	Off
1000 (BACnet Router)	device:1000 (BACnet Router)	vendor-identifier	37	Off
1991 (WeatherLink_1)	device:1991 (WeatherLink_1)	max-apdu-length-accepted	1458	Off
1991 (WeatherLink_1)	device:1991 (WeatherLink_1)	object-name	WeatherLink_1	Off
1991 (WeatherLink_1)	device:1991 (WeatherLink_1)	vendor-identifier	37	Off
2982 (Fike_Panel_01)	device:2982 (Fike_Panel_01)	max-apdu-length-accepted	1458	Off
2982 (Fike_Panel_01)	device:2982 (Fike_Panel_01)	object-name	Fike_Panel_01	Off
2982 (Fike_Panel_01)	device:2982 (Fike_Panel_01)	vendor-identifier	153	Off
4499 (BACnet Router)	device:4499 (BACnet Router)	max-apdu-length-accepted	1458	Off
4499 (BACnet Router)	device:4499 (BACnet Router)	object-name	BACnet Router	Off
4499 (BACnet Router)	device:4499 (BACnet Router)	vendor-identifier	37	Off

Total Items: 36 (Showing Items: 12)

Figure 30: Device List

7.2 View Device Details and Explore Points/Parameters

- To view the device details, click the blue plus sign (+) next to the desired device in the list.
 - This will show only some of the device properties for the selected aspect of a device

Object	Property	Value	Monitor
device:1991 (WeatherLink_1)	max-apdu-length-accepted	1458	Off
device:1991 (WeatherLink_1)	object-name	WeatherLink_1	Off
device:1991 (WeatherLink_1)	vendor-identifier	37	Off

Total Items: 36 (Showing Items: 3)

Figure 31: Device Sub-items

- To view the full details of a device, highlighting the device directly (in Figure 32 “1991 WeatherLink_1”) and click the Explore button (🔍) that appears to the right of the highlighted device as a magnifying glass icon or double-click the highlighted device.

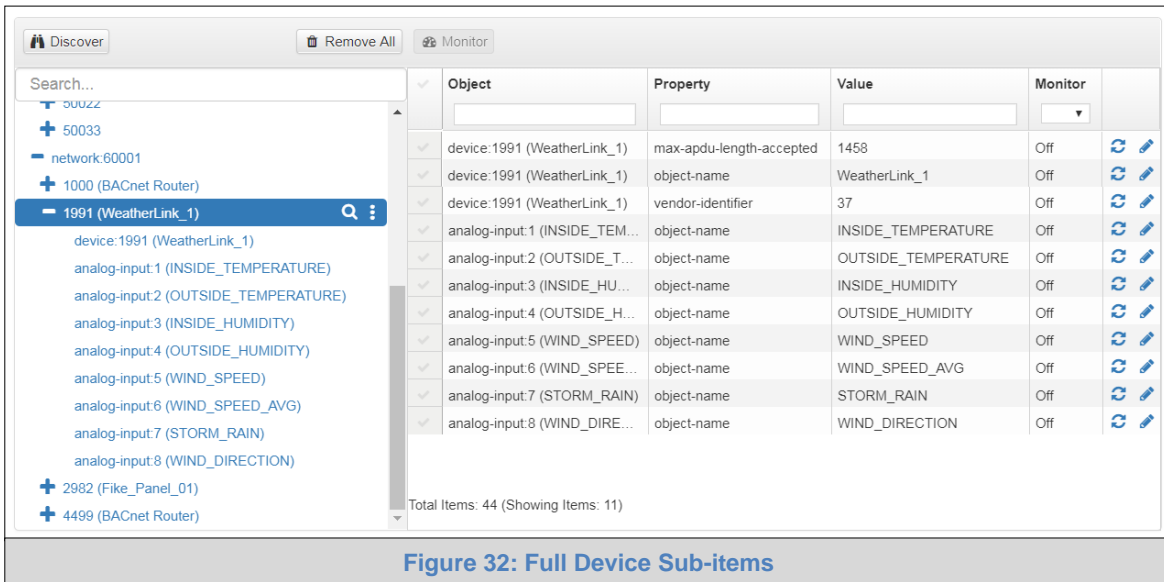

Figure 32: Full Device Sub-items

- Now additional device details are viewable; however, the device can be explored even further
- Click on one of the device details.

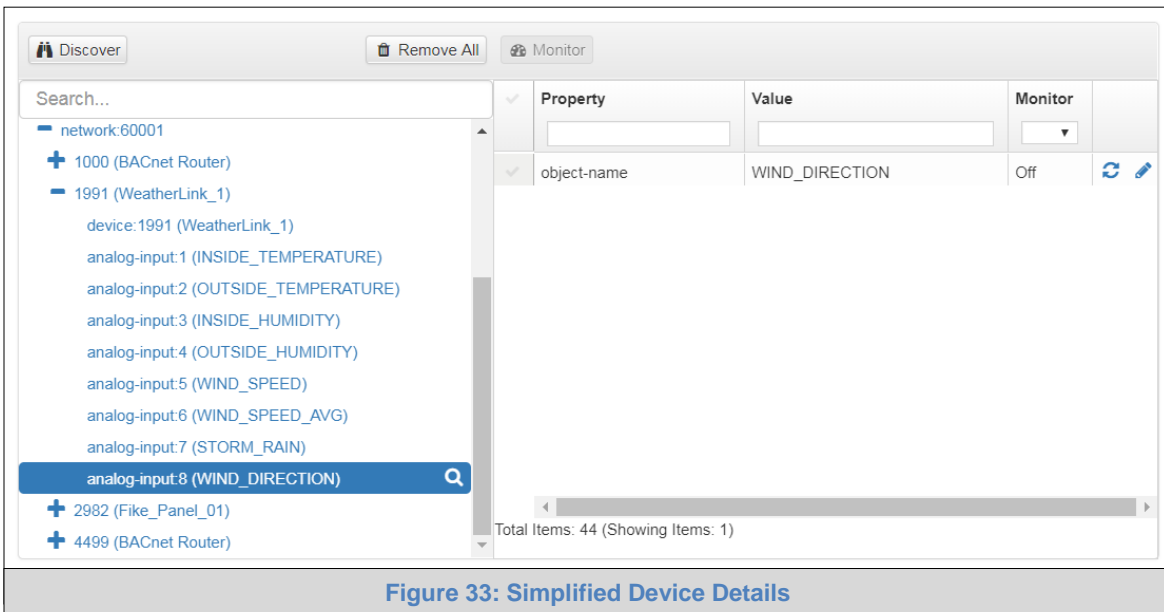

Figure 33: Simplified Device Details

- Then click on the Explore button or double-click the device object.

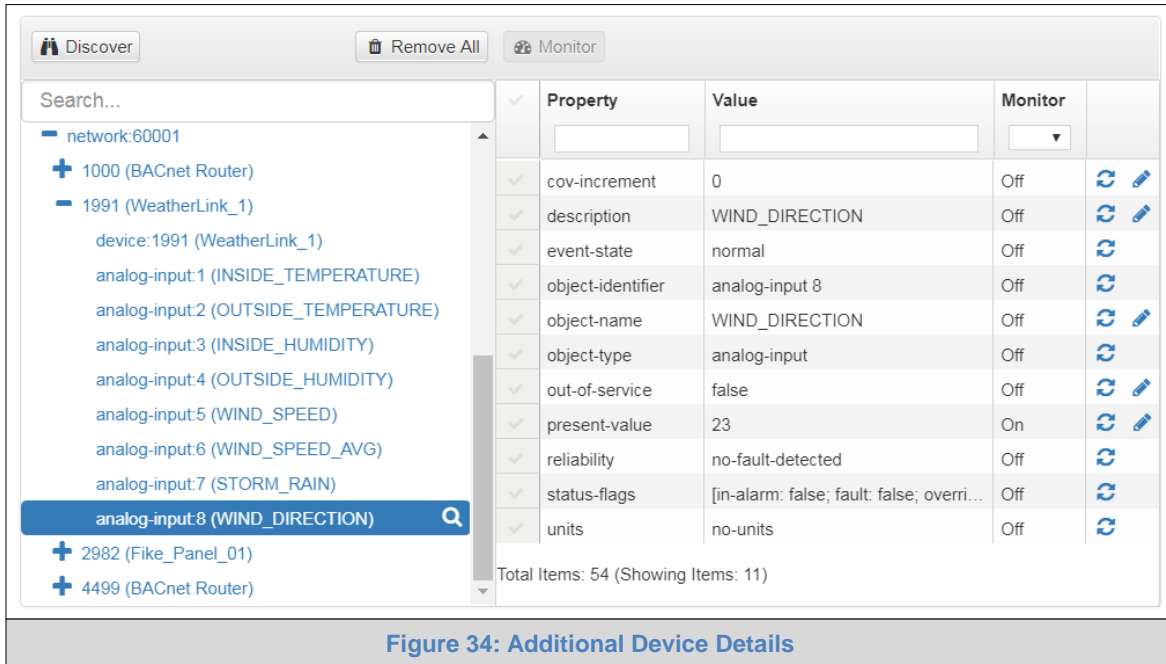

Figure 34: Additional Device Details

A full list of the device details will appear on the right side window. If changes are expected since the last explore, simply press the Refresh button (🔄) that appears to right of individual properties to refresh the value.

NOTE: The Explorer Search Bar will find devices based on their Device ID.

NOTE: The Explorer Discovery Tree has 3 levels that correspond to the following.

- **Network number**
 - **Device**
 - **Device object**

7.2.1 Edit the Present Value Field

The only recommended field to edit via BACnet Explorer is the device's present value field.

NOTE: Other BACnet properties are editable (such as object name, object description, etc.); however, this is not recommended because the BACnet Explorer is a discovery tool not a Building Management System (BMS).

- To edit the present value, select it in the property listings.

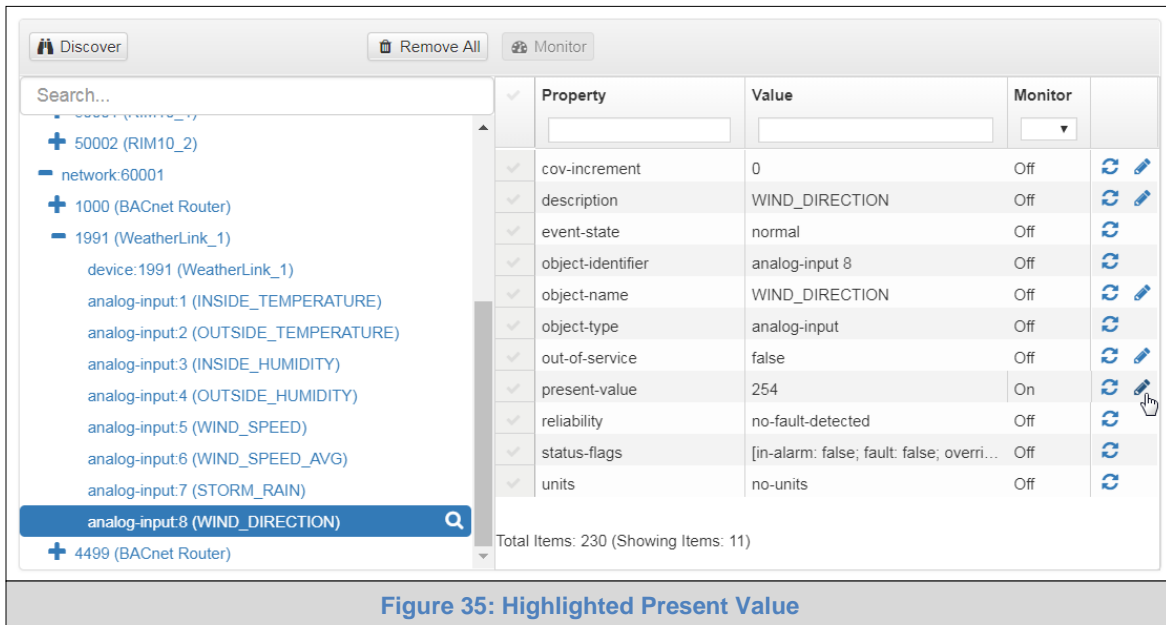



Figure 35: Highlighted Present Value

- Then click the Write button () on the right of the property to bring up the Write Property window.

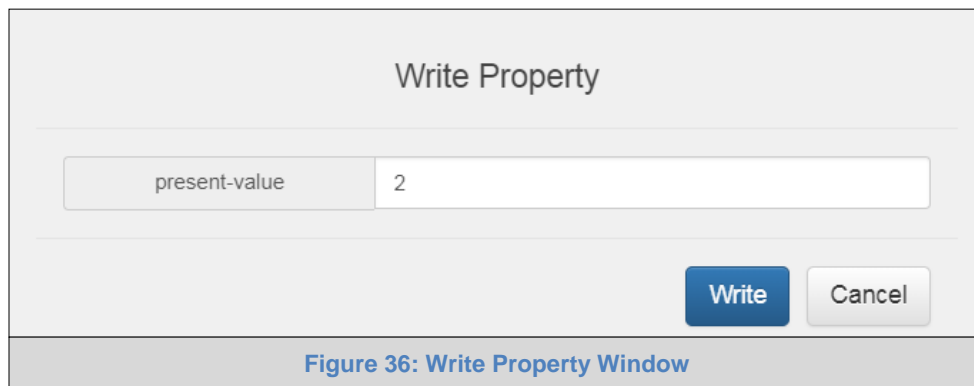
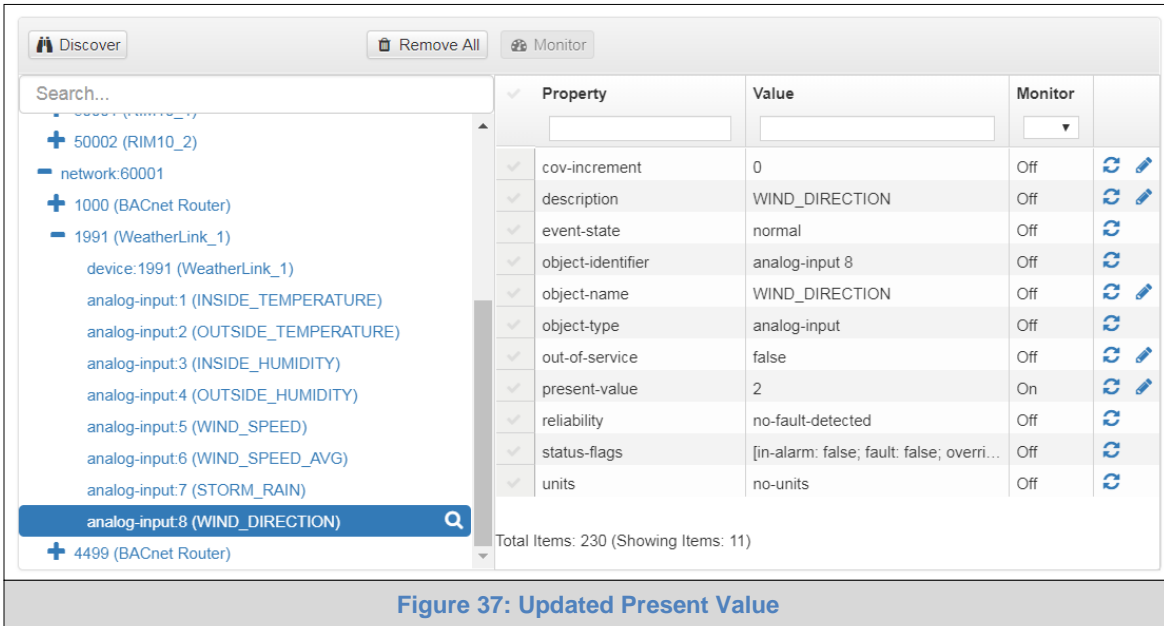

Figure 36: Write Property Window

- Enter the appropriate change and click the Write button.

The window will close. When the BACnet Explorer page appears, the present value will be changed as specified.



8 CONNECTING TO THE SMC CLOUD

8.1 Create a New SMC Cloud Account

The first step to connecting to the SMC Cloud is to create an account.

- Click on the FieldPoP™ tab across the top of the screen.

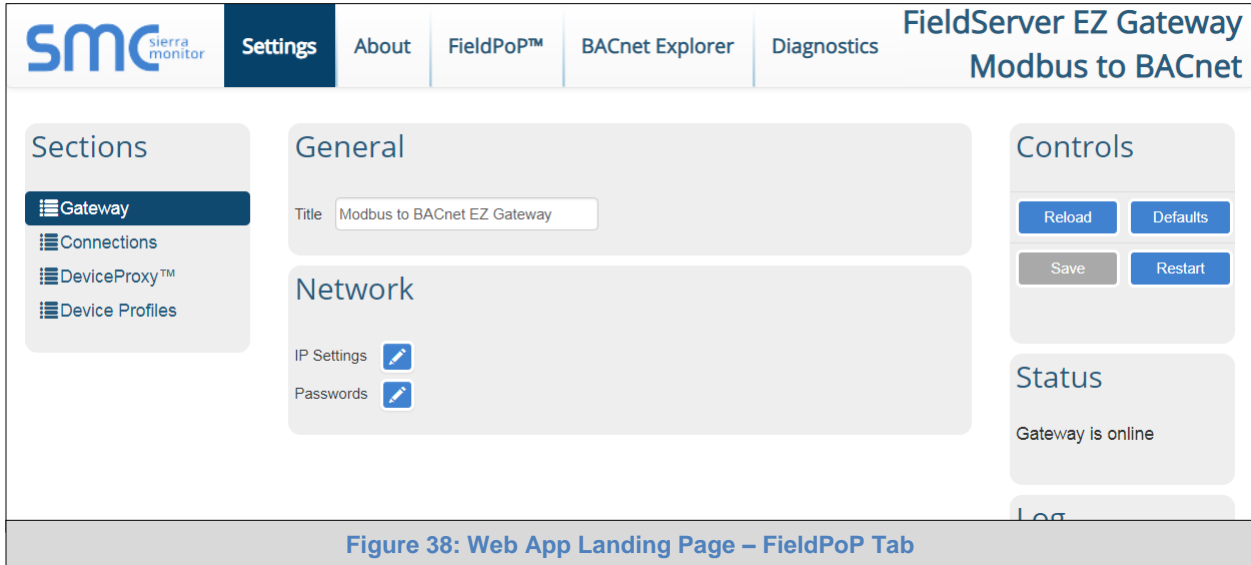

Figure 38: Web App Landing Page – FieldPoP Tab

- The following informational splash page will appear, click Close to view the registration page.

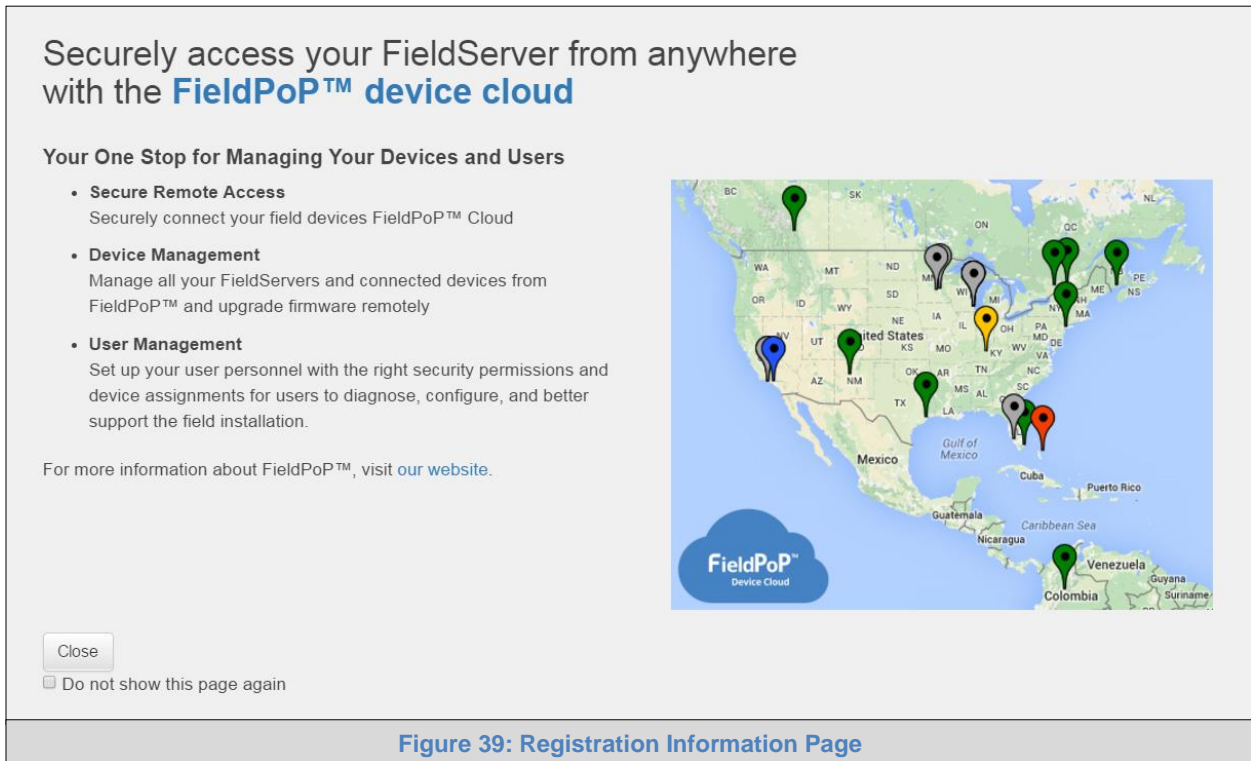

Figure 39: Registration Information Page

- If a warning message appears instead of the splash page, follow the suggestion that appears on screen.
- If the EZ Gateway cannot reach the SMC Cloud server, the following message will appear.



- Follow the directions presented in the warning message and check that the DNS settings are set up with the following Domain Name Server (DNS) settings:
 - DNS1=8.8.8.8
 - DNS2=8.8.4.4
- Ensure that the EZ Gateway is properly connected to the Internet

NOTE: If changes to the network settings are done, remember to click “Update IP Settings” and then power cycle the EZ Gateway.

- On the registration page, click the “Create a FieldPoP account” button and enter a valid email.
 - This will send a “Welcome to SMC Cloud” invite to the email address entered

Register this FieldServer on FieldPoP™

New Users

If you do not have FieldPoP credentials, you can create a new FieldPoP account now [Create a FieldPoP account](#)

Existing Users - Enter device registration details

User Credentials

Username Invalid value : Please enter a username

Password Invalid value : Please enter a password

Device Details

Device Name

Device Description

Device Location

Automatically get current location [Get Current Location](#)

Enter the address and get device location

Latitude:

Longitude:

Select device location on map



[Register Device](#)

Figure 41: SMC Cloud Registration Page

- The “Welcome to SMC Cloud” email will appear as shown below.

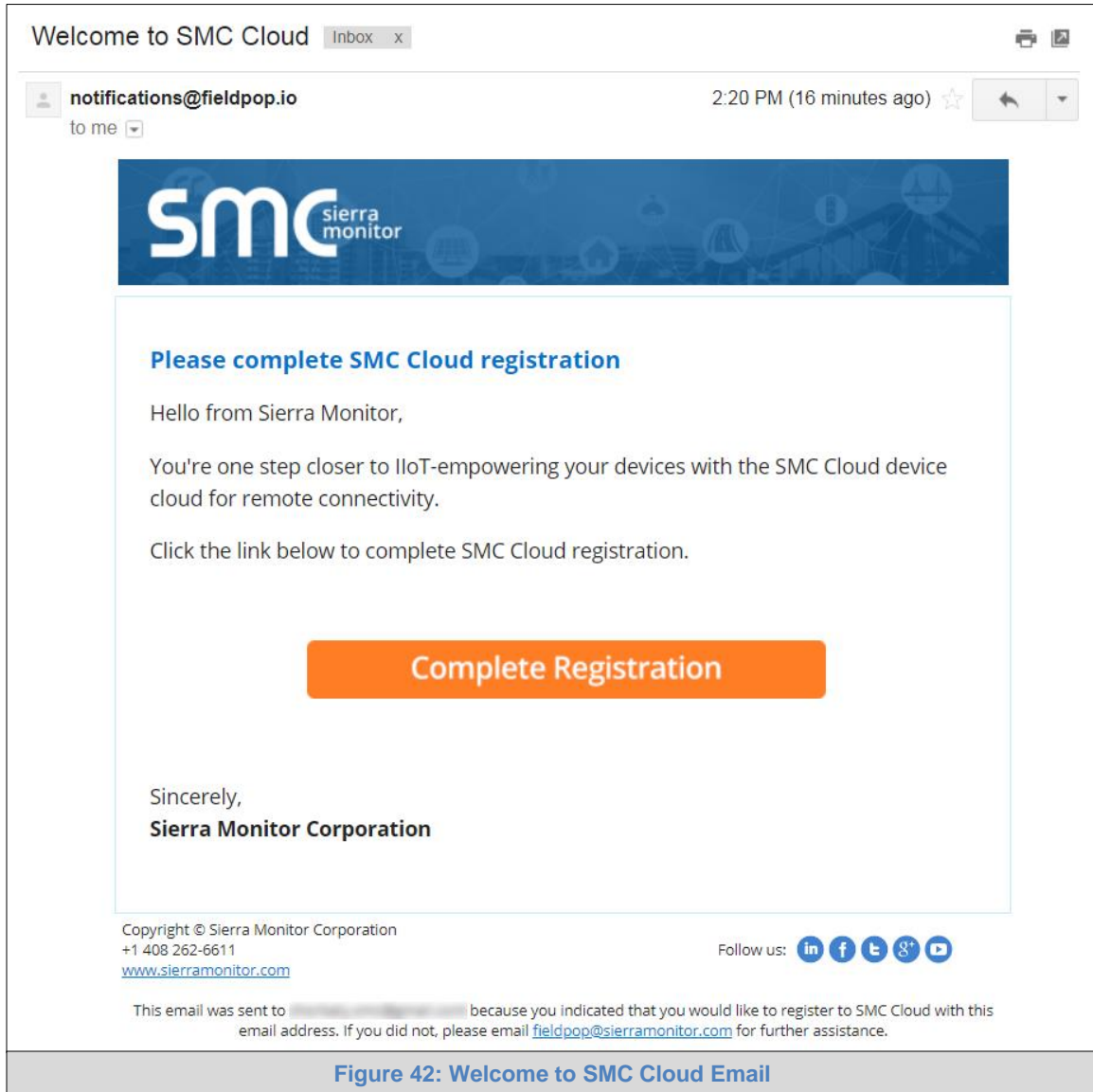

Figure 42: Welcome to SMC Cloud Email

NOTE: If no SMC Cloud email was received, check the spam/junk folder for an email from notification@fieldpop.io. Contact the manufacturer’s support team if the email cannot be found.

- Click the “Complete Registration” button and fill in user details accordingly.

Complete Your Registration

Email Address
user@gmail.com

First Name *

Last Name *

Phone Number *

New Password *

Confirm Password *

By registering my account with SMC, I understand that I am agreeing to the SMC Cloud [Terms of Service](#) and [Privacy Policy](#) *

* Mandatory Fields

Save Cancel

Figure 43: Setting User Details

- Fill in the name, phone number, password fields and click the checkbox to agree to the privacy policy and terms of service.
- Click “Save” to save the user details.
- Click “OK” on when the Success message appears.
- Record the email account used and password for future use.

8.2 Registration Process

Once SMC Cloud user credentials have been generated, the EZ Gateway can be registered onto the SMC Cloud server.

- On the registration page, fill in user credentials and all other device information fields for registration of each individual gateway in the field.

Figure 44: Register the Gateway on the SMC Cloud

- To input the device location, do one of the following:
 - Enter the address in the address field
 - Click the “Get Current Location” button to auto-populate

NOTE: This button will only work if location services have been enabled on the local browser. If using the Chrome browser and connected via LAN, this method will not work.

- Drop a location directly on the Google map
- Enter the latitude and longitude manually
- Click Register Device.

- Once the device has successfully been registered, the following screen will appear listing the device details and additional information auto-populated by the EZ Gateway.



Figure 45: Device Registered for SMC Cloud

8.3 Login to SMC Cloud

After the EZ Gateway is registered, go to www.smccloud.net and type in the appropriate login information as per registration credentials.

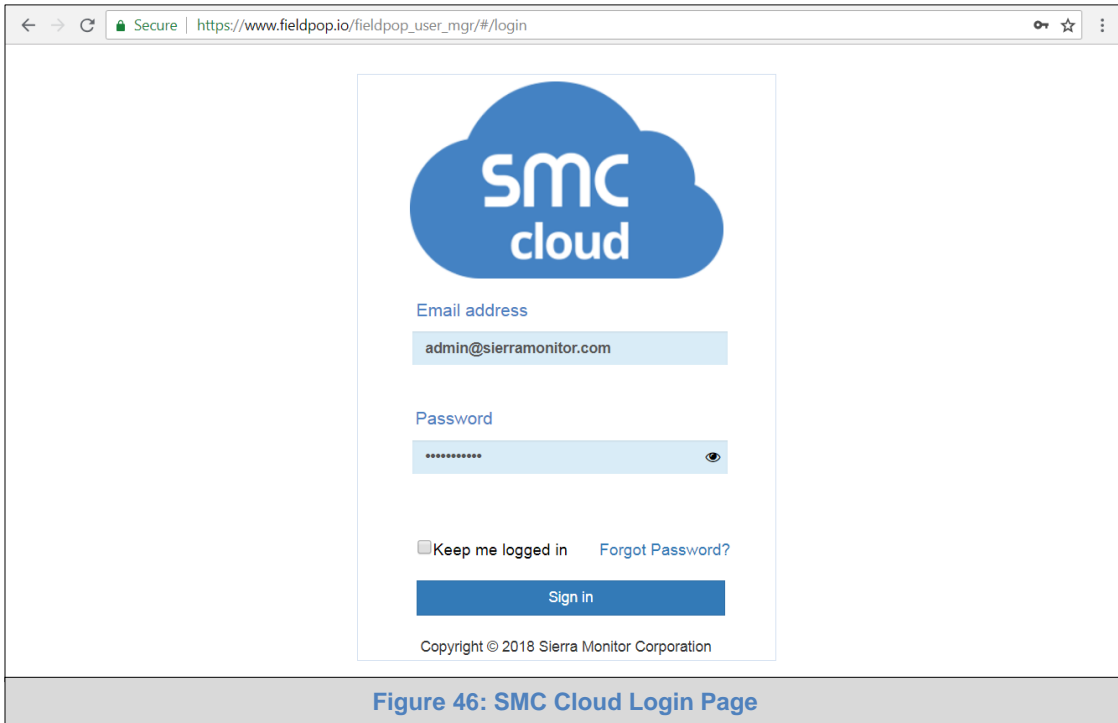

Figure 46: SMC Cloud Login Page

NOTE: If the login password is lost, see the SMC Cloud Start-up Guide for recovery instructions.

On first login, the Privacy Policy window will appear. Read the Terms of Service, click the checkbox to accept the terms and then click the Continue button to access SMC Cloud.

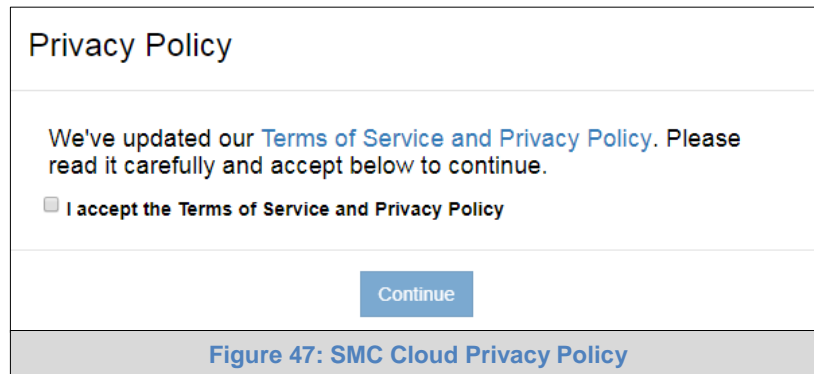

Figure 47: SMC Cloud Privacy Policy

NOTE: For additional SMC Cloud instructions see the [SMC Cloud Start-up Guide](#).

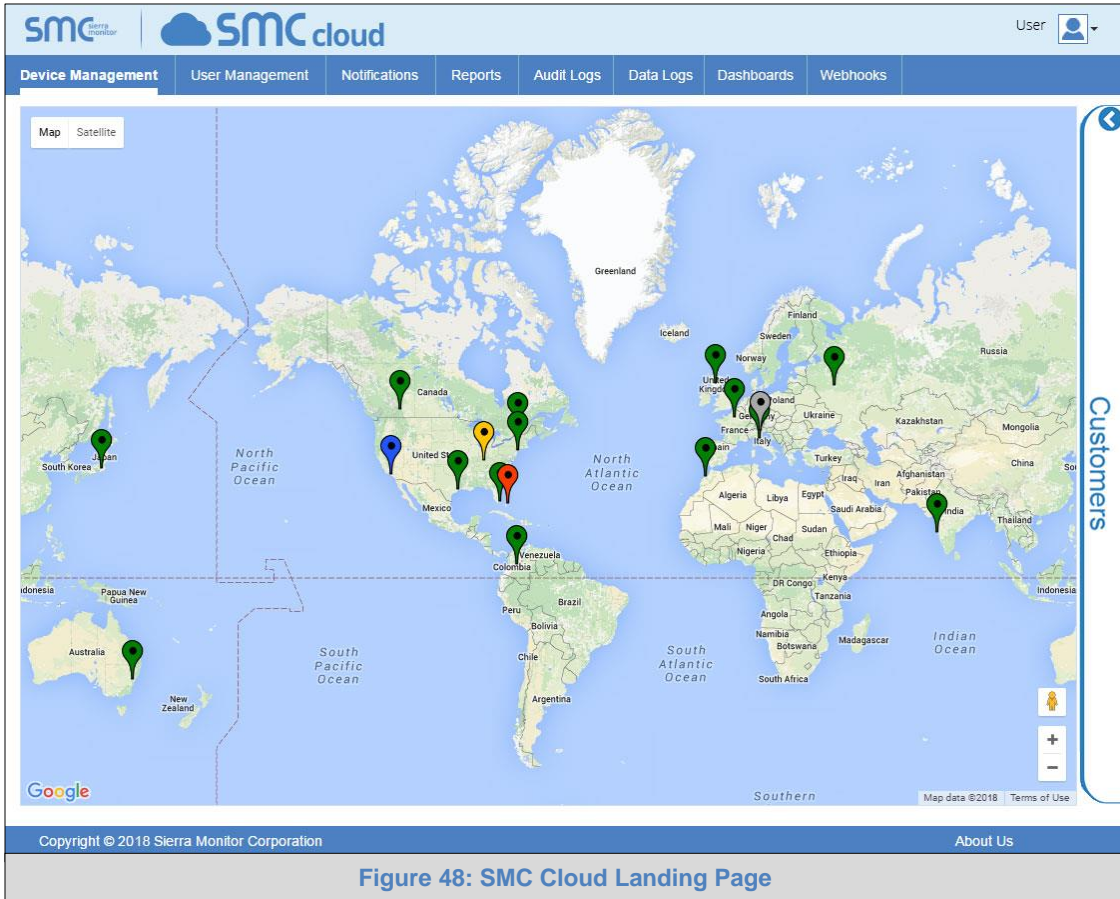

Figure 48: SMC Cloud Landing Page

Appendix A Troubleshooting

Appendix A.1. Communicating with the EZ Gateway Over the Network

- Confirm that the network cabling is correct.
- Confirm that the computer network card is operational and correctly configured.
- Confirm that there is an Ethernet adapter installed in the PC's Device Manager List, and that it is configured to run the TCP/IP protocol.
- Check that the IP netmask of the PC matches the EZ Gateway. The Default IP Address of the EZ Gateway is 192.168.2.X, Subnet Mask is 255.255.255.0.
 - Go to Start|Run
 - Type in "ipconfig"
 - The account settings should be displayed
 - Ensure that the IP Address is 102.168.2.X and the netmask 255.255.255.0
- Ensure that the PC and EZ Gateway are on the same IP Network, or assign a Static IP Address to the PC on the 192.168.2.X network.

Appendix A.2. Notes Regarding Subnets and Subnet Masks

RFC standards allocate the IP Address range of 192.0.0.0 through to 223.255.255.255 to be used in Class-C subnetting (subnets listed as 255.255.255.xxx, where xxx can vary based on filtering required).

Consequently, the IP stack for this product will not allow any IP Addresses in this range to be allocated a subnet that does not fall within the Class C range.

Appendix A.3. Before Contacting Technical Support Take a Diagnostic Capture

When there is a problem on-site that cannot easily be resolved, perform a diagnostic capture before contacting support so that support can quickly solve the problem. There are two methods for taking diagnostic captures:

- FieldServer Toolbox:**
 This method requires installation of the FS Toolbox program. A FS Toolbox diagnostic capture takes a snapshot of the loaded configuration files and a log of all the communications on the serial ports over a specified period of time. If the problem occurs over an Ethernet connection, then take a Wire Shark capture.
- Gateway’s FS-GUI Page:**
 This method doesn’t require downloading software. The diagnostic capture utilities are embedded in the FS-GUI web interface. Starting a diagnostic capture takes a snapshot of the loaded configuration files and a log of all the communications over a specified period of time. This works for both serial and Ethernet connections.

NOTE: The information in the zipped files contains everything support needs to quickly resolve problems that occur on-site.

Appendix A.3.1. Using the FieldServer Toolbox

Once the Diagnostic Capture is complete, email it to technical support. The Diagnostic Capture will accelerate diagnosis of the problem.

NOTE: While all necessary documentation is shipped with the FieldServer on the USB flash drive, these documents are constantly being updated. Newer versions may be available on the [Sierra Monitor website](#).

- Ensure that FieldServer Toolbox is loaded onto the local PC. Otherwise, download the FieldServer-Toolbox.zip via the Sierra Monitor [Software Downloads](#).
- Extract the executable file and complete the installation.

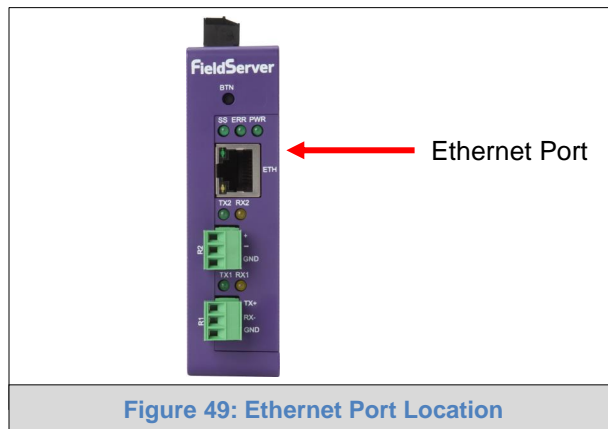

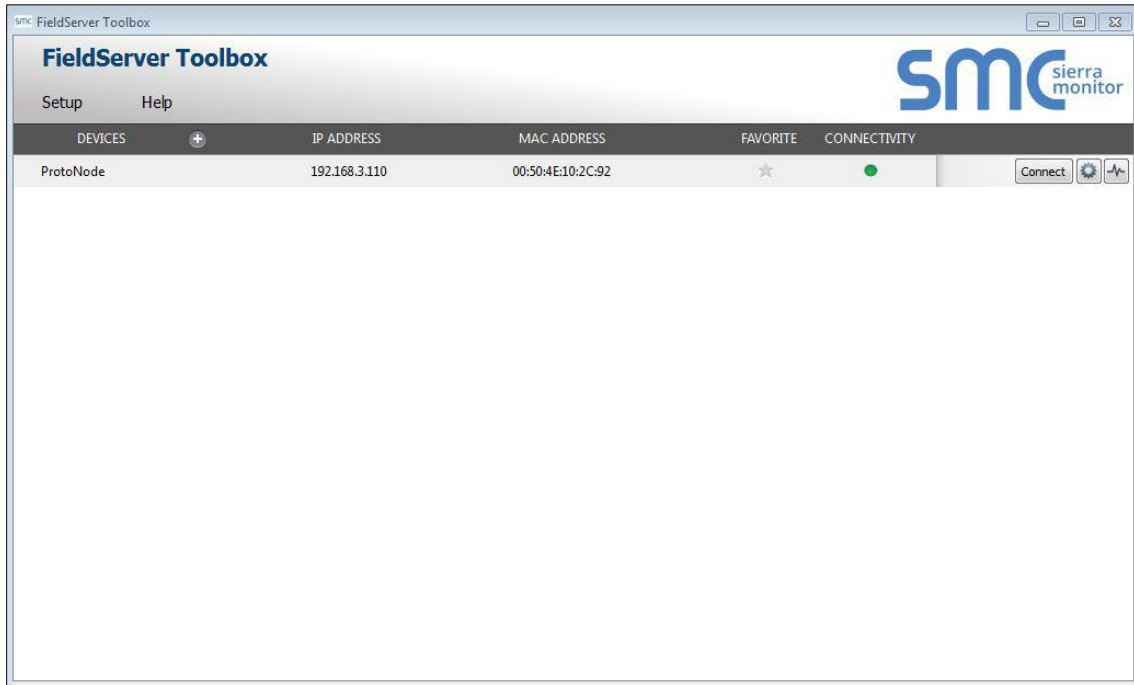

Figure 49: Ethernet Port Location

- Connect a standard Cat-5 Ethernet cable between the PC and FieldServer.
- Double click on the FS Toolbox Utility.

- **Step 1: Take a Log**
 - Click on the diagnose icon  of the desired device



- Ensure "Full Diagnostic" is selected (this is the default)

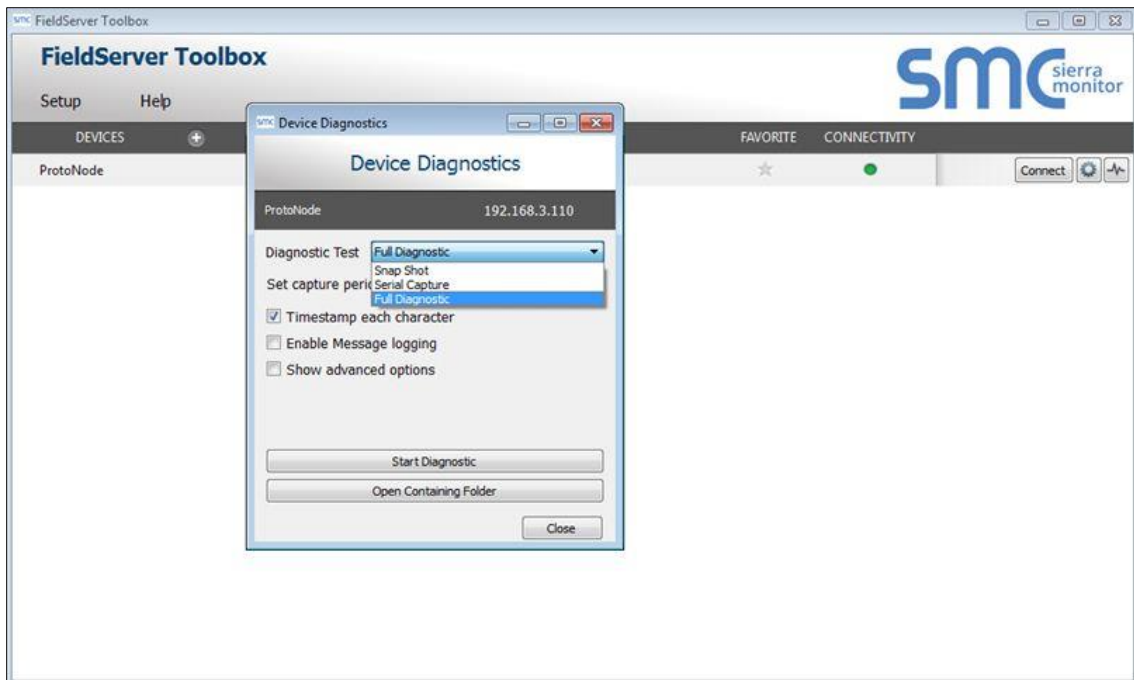

NOTE: If desired, the default capture period can be changed.

- Click on “Start Diagnostic”

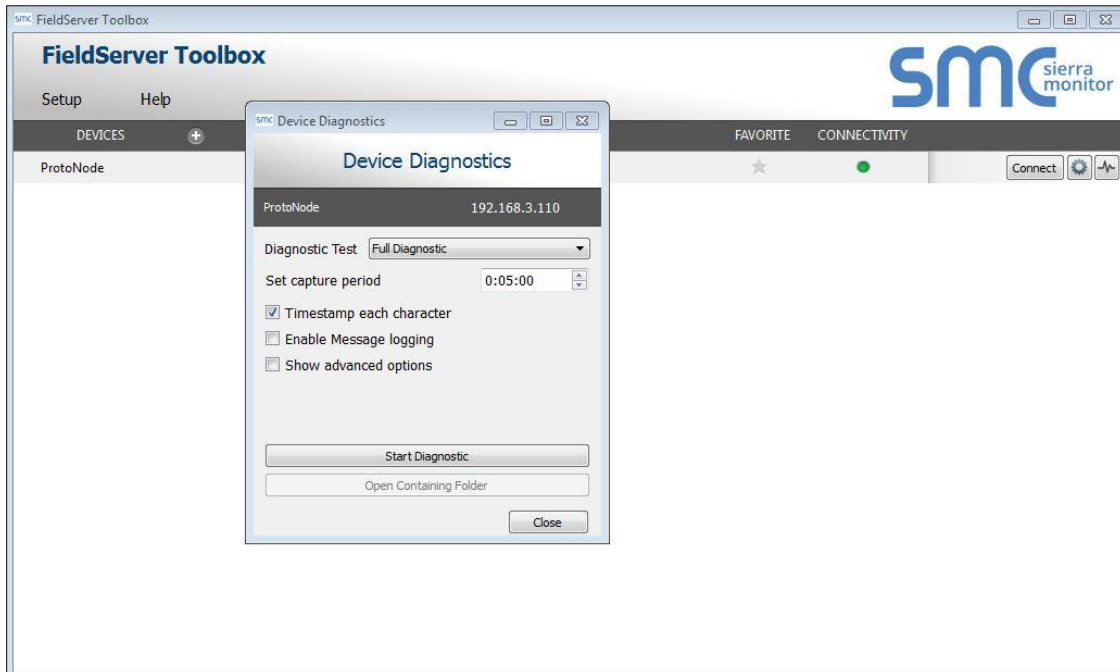

- Wait for Capture period to finish, then the Diagnostic Test Complete window will appear
- **Step 2: Send Log**
 - Once the Diagnostic test is complete, a .zip file will be saved on the PC

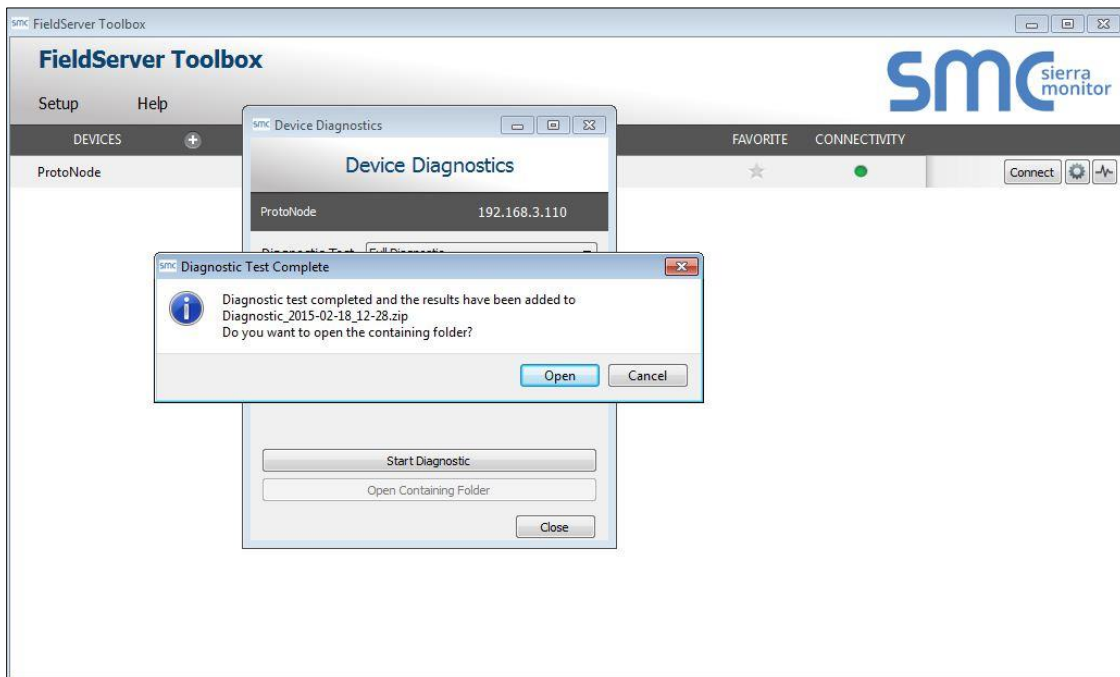

- Choose “Open” to launch explorer and have it point directly at the correct folder
- Send the Diagnostic zip file to support@sierramonitor.com

 Diagnostic_2014-07-17_20-15.zip 2014/07/17 20:16 zip Archive 676 KB

Appendix A.3.2. Using FS-GUI

Diagnostic Capture with FS-GUI is only available on FieldServers with a bios updated/released on November 2017 or later. Completing a Diagnostic Capture through the FieldServer allows network connections (such as Ethernet and Wi-Fi) to be captured.

Once the Diagnostic Capture is complete, email it to technical support. The Diagnostic Capture will accelerate diagnosis of the problem.

- Open the FieldServer FS-GUI page.
- Click on Diagnostics in the Navigation panel.

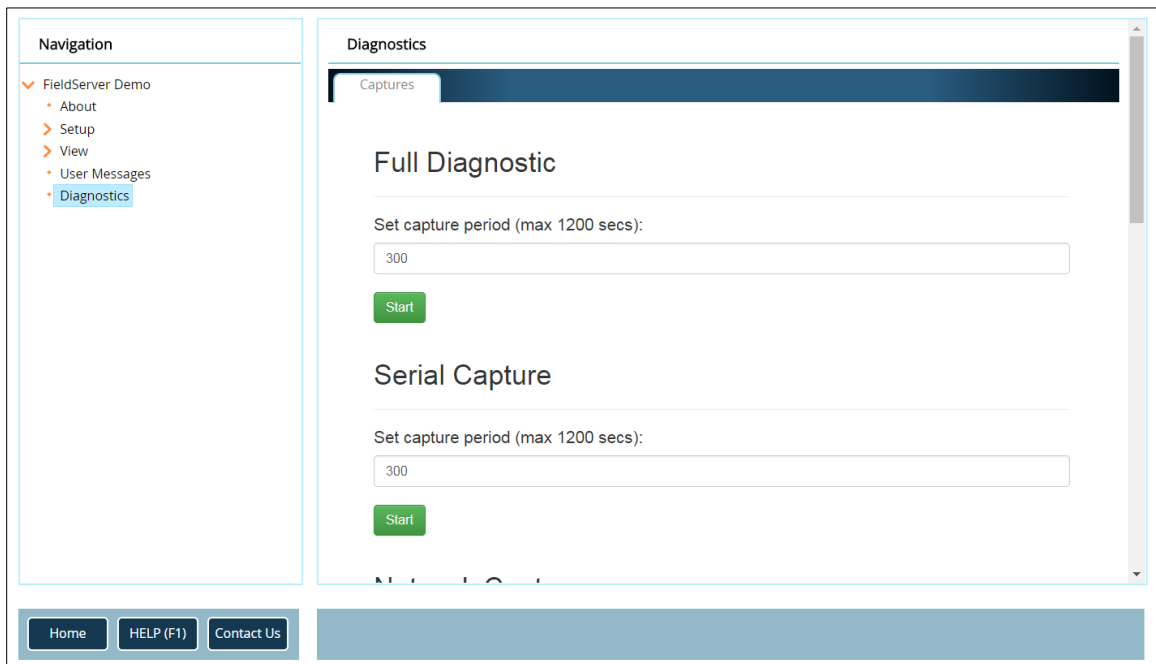

- Go to Full Diagnostic and select the capture period.
- Click the Start button under the Full Diagnostic heading to start the capture.
 - When the capture period is finished, a Download button will appear next to the Start button

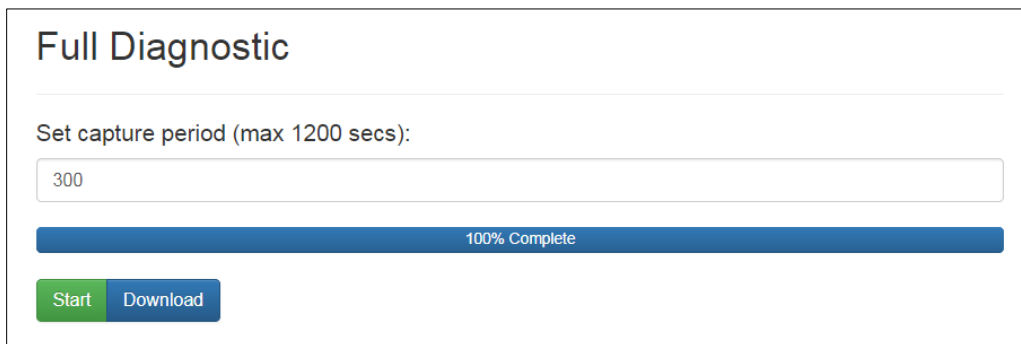

- Click Download for the capture to be downloaded to the local PC.
- Send the diagnostic zip file to support@sierramonitor.com.

NOTE: Diagnostic captures of BACnet MS/TP communication are output in a “.PCAP” file extension which is compatible with Wireshark.

Appendix A.4. LED Functions

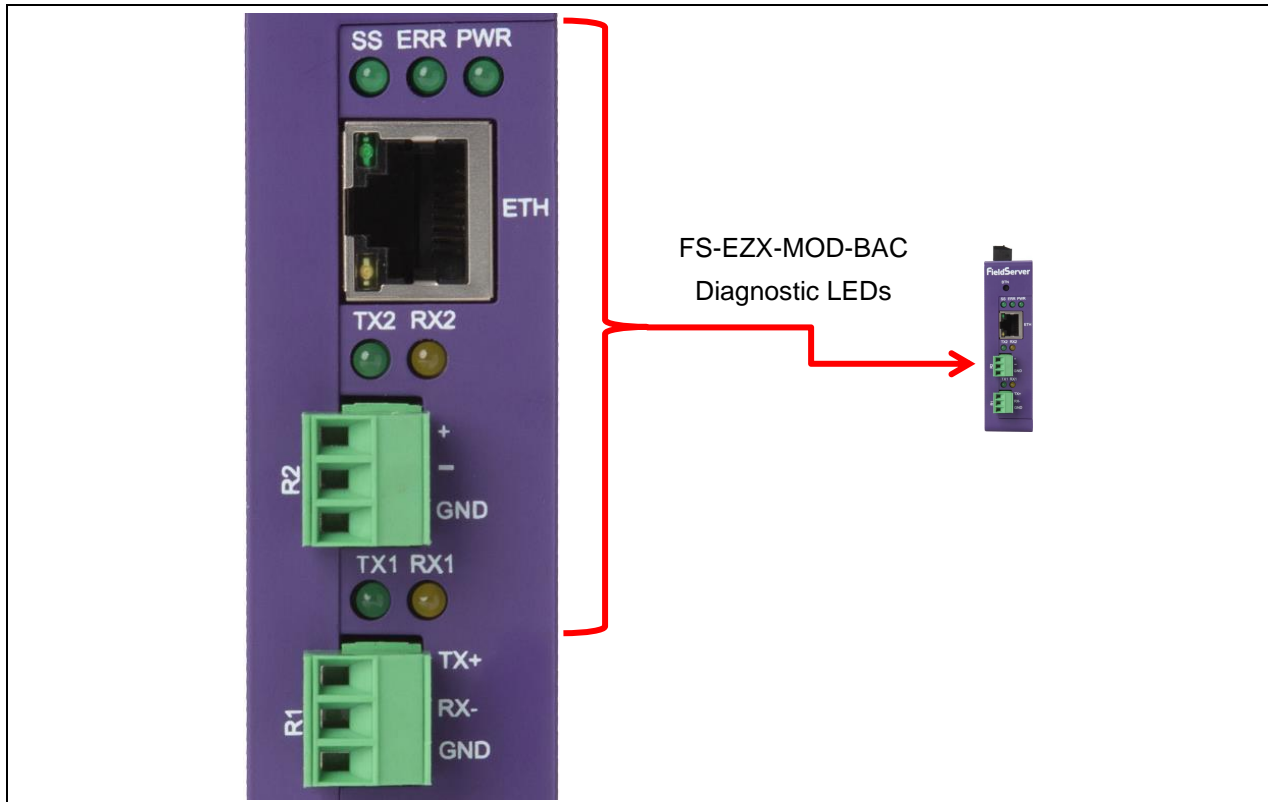

Tag	Description
SS	The SS LED will light if the unit is not getting a response from one or more of the configured devices.
ERR	The SYS ERR LED will go on solid indicating there is a system error. If this occurs, immediately report the related “system error” shown in the error screen of the FS-GUI interface to support for evaluation.
PWR	This is the power light and should always be steady green when the unit is powered.
RX	The RX LED will flash when a message is received on the serial port on the 3-pin connector. If the serial port is not used, this LED is non-operational. RX1 applies to the R1 connection while RX2 applies to the R2 connection.
TX	The TX LED will flash when a message is sent on the serial port on the 3-pin connector. If the serial port is not used, this LED is non-operational. TX1 applies to the R1 connection while TX2 applies to the R2 connection.

Figure 50: Diagnostic LEDs

Appendix A.5. Factory Reset Instructions

For instructions on how to reset a FieldServer back to its factory released state, see [ENOTE - FieldServer Next Gen Recovery](#).

Appendix A.6. Internet Browsers Not Supported

- Internet Explorer 11 and prior versions

Appendix B Reference

Appendix B.1. Specifications



FS-EZ3-MOD-BAC & FS-EZ4-MOD-BAC ²	
Electrical Connections	One 3-pin Phoenix connector with: RS-485/RS-232 (Tx+ / Rx- / gnd) One 3-pin Phoenix connector with: RS-485 (Tx+ / Rx- / gnd) One 3-pin Phoenix connector with: Power port (+ / - / Frame-gnd) One Ethernet 10/100 BaseT port
Power Requirements	<i>Input Voltage:</i> 12-24VDC or 24VAC <i>Current draw:</i> 24VAC 125mA <i>Max Power:</i> 3 Watts 12-24VDC 250mA @12VDC
Approvals	CE and FCC class B & C part 15, UL 60950, WEEE compliant, IC Canada, RoHS compliant
Power Requirements	12-24VDC or 24VAC
Physical Dimensions	4 x 1.1 x 2.7 in (10.16 x 2.8 x 6.8 cm)
Weight	0.4 lbs (0.2 Kg)
Operating Temperature	-20°C to 70°C (-4°F to 158°F)
Humidity	10-95% RH non-condensing

Figure 51: Specifications

“This device complies with part 15 of the FCC Rules. Operation is subject to the following two conditions:

- This device may not cause harmful interference
- This device must accept any interference received, including interference that may cause undesired operation.

NOTE: This equipment has been tested and found to comply with the limits for a Class A digital device, pursuant to part 15 of the FCC Rules. These limits are designed to provide reasonable protection against harmful interference when the equipment is operated in a commercial environment. This equipment generates, uses, and can radiate radio frequency energy and, if not installed and used in accordance with the instruction manual, may cause harmful interference to radio communications. Operation of this equipment in a residential area is likely to cause harmful interference in which case the user will be required to correct the interference at his expense. Modifications not expressly approved by Sierra Monitor could void the user's authority to operate the equipment under FCC rules”.

² Specifications subject to change without notice.

Appendix B.2. Compliance with UL Regulations

For UL compliance, the following instructions must be met when operating the EZ Gateway.

- The units shall be powered by listed LPS or Class 2 power supply suited to the expected operating temperature range.
- The interconnecting power connector and power cable shall:
 - Comply with local electrical code
 - Be suited to the expected operating temperature range
 - Meet the current and voltage rating for the EZ Gateway
- Furthermore, the interconnecting power cable shall:
 - Be of length not exceeding 3.05m (118.3")
 - Be constructed of materials rated VW-1, FT-1 or better
- If the unit is to be installed in an operating environment with a temperature above 65 °C, it should be installed in a Restricted Access Area requiring a key or a special tool to gain access.
- This device must not be connected to a LAN segment with outdoor wiring.

Appendix B.3. Dimension Drawing FS-EZX-MOD-BAC

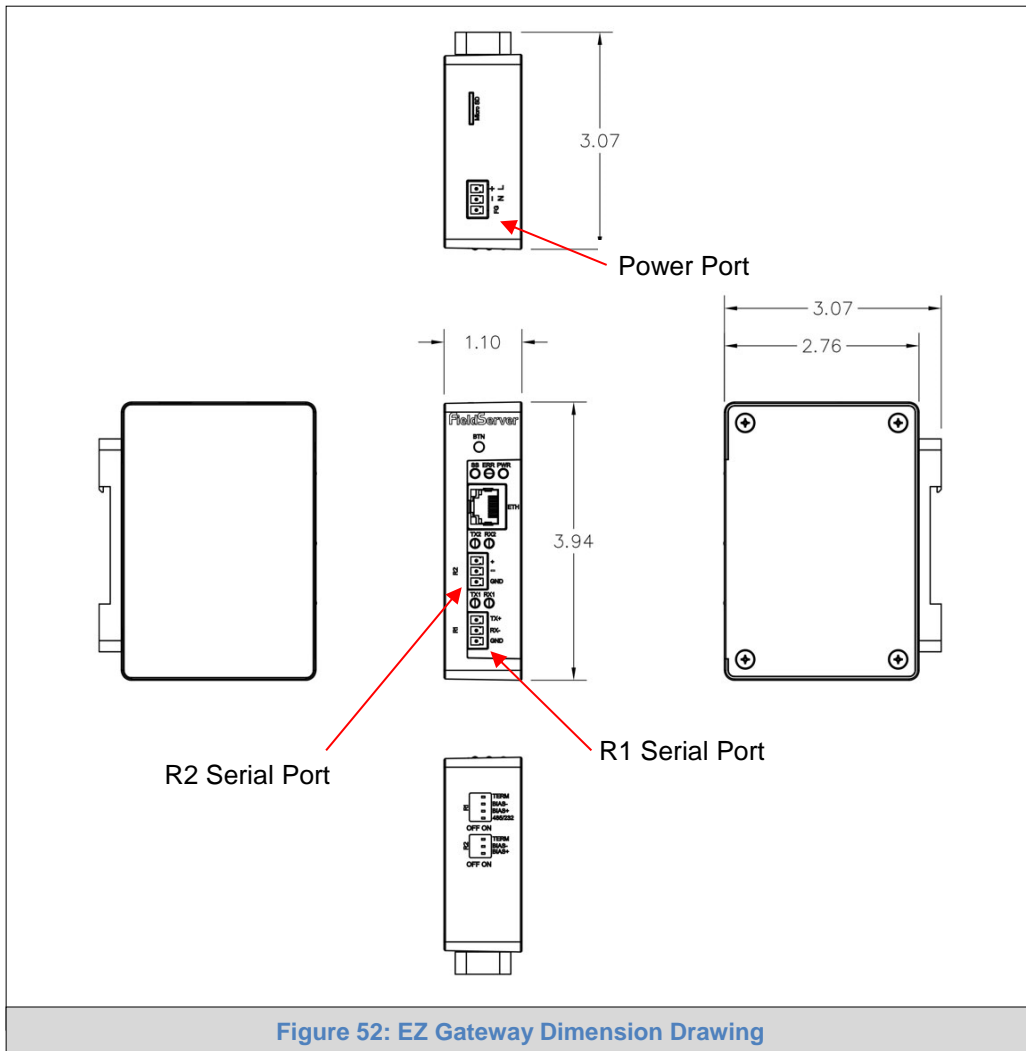

Figure 52: EZ Gateway Dimension Drawing

Appendix B.4. Address Types and Data Types

If the node parameter Address_Type is set as ADU or PDU, then Data_Type must be specified as follows.

For Address_Type ADU:

Address range	Data_Type	Function Code (Write)	Function Code (Read)
1 - 65536	Coil	15	1
1 – 65536	Discrete_Input	n/a.	2
1 – 65536	Input_Register	n/a.	4
1 - 65536	Holding_Register	16	3

For Address_Type PDU:

Address range	Data_Type	Function Code (Write)	Function Code (Read)
0 - 65535	FC01	15	1
0 – 65535	FC02	n/a.	2
0 – 65535	FC04	n/a.	4
0 – 65535	FC03	16	3

For Address_Type Modicon_5digit:

When a Modbus address range is specified, a particular Data Type is implied. The defaults are shown below.

Address range	Data_Type	Function Code (Write)	Function Code (Read)
00001 - 09999	Coil	5,15	1
10001 - 19999	Discrete_Input	n/a.	2
30001 - 39999	Input_Register	n/a.	4
40001 - 49999	Holding_Register	6,16	3

Appendix C Limited 2 Year Warranty

Sierra Monitor Corporation warrants its products to be free from defects in workmanship or material under normal use and service for two years after date of shipment. Sierra Monitor Corporation will repair or replace any equipment found to be defective during the warranty period. Final determination of the nature and responsibility for defective or damaged equipment will be made by Sierra Monitor Corporation personnel.

All warranties hereunder are contingent upon proper use in the application for which the product was intended and do not cover products which have been modified or repaired without Sierra Monitor Corporation's approval or which have been subjected to accident, improper maintenance, installation or application, or on which original identification marks have been removed or altered. This Limited Warranty also will not apply to interconnecting cables or wires, consumables or to any damage resulting from battery leakage.

In all cases Sierra Monitor Corporation's responsibility and liability under this warranty shall be limited to the cost of the equipment. The purchaser must obtain shipping instructions for the prepaid return of any item under this warranty provision and compliance with such instruction shall be a condition of this warranty.

Except for the express warranty stated above, Sierra Monitor Corporation disclaims all warranties with regard to the products sold hereunder including all implied warranties of merchantability and fitness and the express warranties stated herein are in lieu of all obligations or liabilities on the part of Sierra Monitor Corporation for damages including, but not limited to, consequential damages arising out of/or in connection with the use or performance of the product.