

SKD...U Electronic Valve Actuator

Product Description

The SKD...U actuator requires a 24 Vac supply signal to control a Flowrite™ 599 Series valve with a 3/4-inch (20 mm) stroke.

Product Numbers

Non-Spring Return **Spring Return**



SKD60U

SKD62U

SKD82.50U

SKD82.51U

Warning/Caution Notations

WARNING:		Personal injury or loss of life may occur if you do not follow a procedure as specified.
CAUTION:		Equipment damage or loss of data may occur if you do not follow a procedure as specified.

Required Tools

- 5 mm Allen wrench
- Small and medium flat-blade screwdrivers

Expected Installation Time

20 minutes for factory installed actuator
45 minutes for field replacement of actuator

Prerequisites



WARNING:

If mounting the actuator to a valve already in line, either close the shut-off valves in the piping (upstream first, then downstream) or switch off the pump to allow the differential and static pressure in the valve to drop.

Mounting Positions

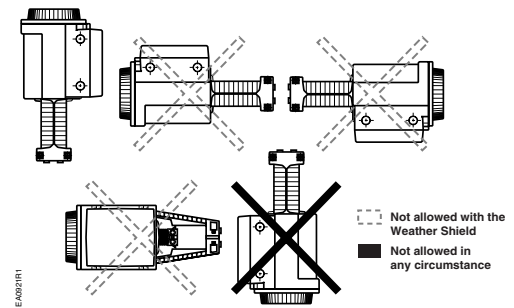

Figure 1. Acceptable Mounting Positions.

Using the Weather Shield

The SKD must be in the vertical position. Complete instructions for the mounting of the Weather Shield are included with that product.

NOTE: Use the top knockout position when installing the Weather Shield. See Figure 16.

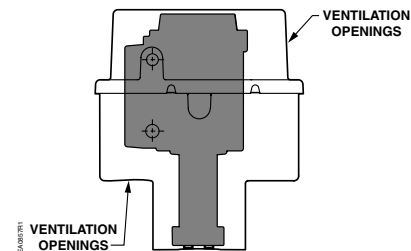

Figure 2. Weather Shield Installation Position.

Installation

If you are mounting an actuator on a new valve, begin with the instructions in Figure 3.

Removing the Actuator from the Valve

1. Remove the actuator cover.
2. Disconnect the wires and conduit, if installed.
3. Loosen the valve stem retainer using a 5 mm Allen wrench and lower the valve stem into the valve.
4. Loosen the yoke nuts using a 5 mm Allen wrench in the actuator yoke.
5. Remove the actuator from the valve, being careful not to damage the valve stem.

Continue with *Mounting an Actuator to a Valve*.

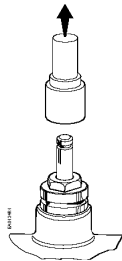

Figure 3. Preparing a new Valve.

Mounting an Actuator to a Valve.

NOTE: Install the packing heating element, (P/N 599-00417), if used, before proceeding.

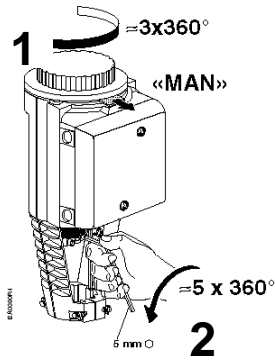

Figure 4.

NOTE: Make sure the yoke nuts are loose enough to allow the actuator to slip over the bonnet. See Figure 5.

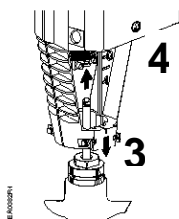

Figure 5.

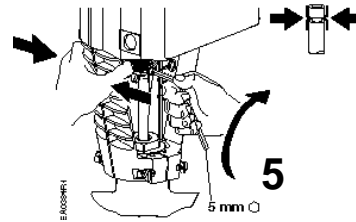

Figure 6.

NOTE: Hold the stem retainer in place as you tighten it around the valve stem. See Figure 6.

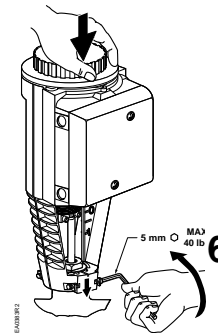

Figure 7.

NOTE: Position the actuator to accommodate the wiring. Hold the actuator in place while tightening the yoke nuts. See Figure 7.

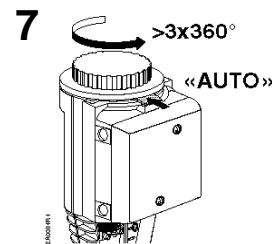

Figure 8.

Wiring



CAUTION:

Use care when removing the knockout. Do not damage the circuit board.

Do not use autotransformers. Use earth ground isolating step-down Class 2 transformers.

Determine supply transformer rating by summing total VA of all actuators used. The maximum rating for a Class 2 power supply circuit is 100 VA.

Actuator	Power Consumption	Actuators Per Class 2 Supply Circuit* (80% of Transformer VA)
SKD6...U	17 VA	4
SKD82.50U	13 VA	8
SKD82.51U	18 VA	5

* Operating more actuators requires additional transformers or separate 100 VA power supplies.

Wiring Diagrams

SKD60U/SKD62U
 SKD82.50U/51U

Figures 9 and 10
 Figures 11 through 13

SKD6...U

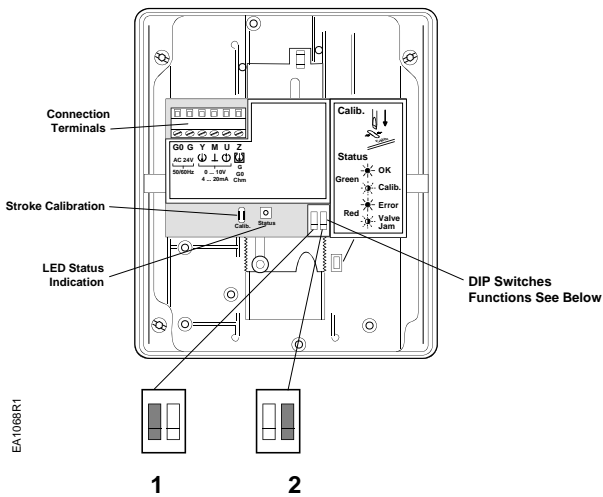

Figure 9. SKD6...U.

DIP Switches	1 Selection of Control Signal	2 Selection of Flow Characteristic
ON	4 to 20 mA	Modified*
OFF (Factory Setting)	0 to 10 Vdc	Default

*Changing the default setting will modify an equal percentage valve to a linear flow characteristic. When set to default, the flow characteristic is determined by the valve body.

Siemens Industry, Inc.

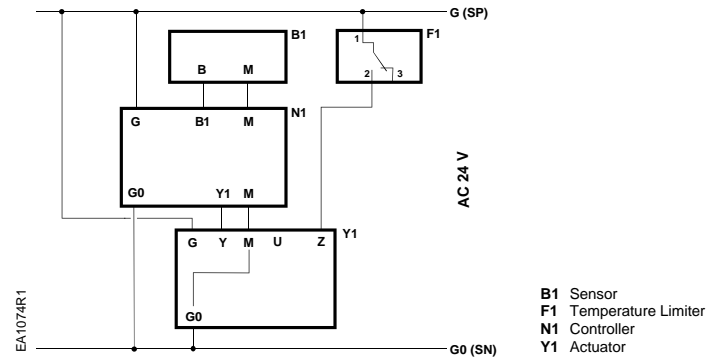

Figure 10.

Connecting Terminals

24 Vac	
G	System Potential (SP)
G0	System Neutral (SN)
Y	Control Input: 0 to 10 Vdc or 4 to 20 mA (DIP switch selectable)
Z	Override Control (See <i>Technical Instructions</i> 155-180P25)
M	Measuring Neutral
U	Output for 0 to 10 Vdc or 4 to 20 mA measuring voltage. It will match the input signal type.

The position output signal U will switch from 0 to 10 Vdc to 4 to 20 mA when a 4 to 20 mA input signal is selected and used on the terminal

Wiring for SKD82...U

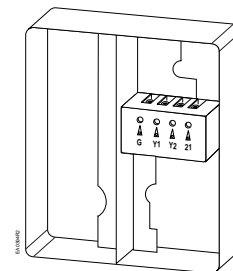

Figure 11. Location of Terminals.

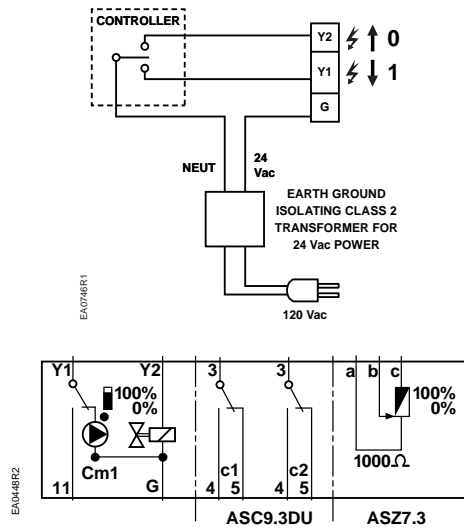

Figure 12. Non-Spring Return SKD82.50U.

Connecting Terminals

G	System Potential 24 Vac (+)
Y1	Outward movement of coupling piece (0 to 1)
Y2	Inward movement of coupling piece (1 to 0)
Cm1	Limit switch for 100% stroke
c1	ASC9.3DU double auxiliary switch
c2	ASC9.3DU double auxiliary switch
1000 Ω	ASZ7.3 potentiometer

The diagram shows all possible connections. How many and which are used depend on the application.

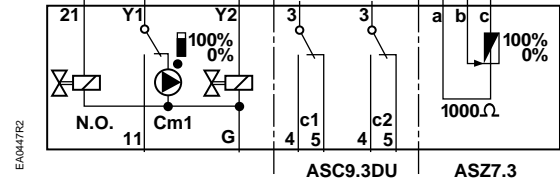
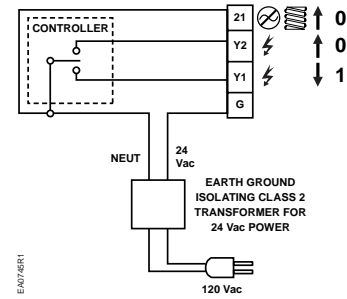

Figure 13. Spring Return SKD82.51U.

Connecting Terminals

G	System Potential 24 Vac (+)
21	System Neutral (SN)
Y1	Outward movement of coupling piece (0 to 1)
Y2	Inward movement of coupling piece (1 to 0)
Cm1	Limit switch for 100% stroke
c1	ASC9.3DU double auxiliary switch
c2	ASC9.3DU double auxiliary switch
1000 Ω	ASZ7.3 potentiometer

The diagram shows all possible connections. How many and which are used depend on the application.

Start-Up

Check the wiring for proper connections.

Consult Technical Instructions 155-180P25 for detailed commissioning information.

Normally Closed Valve

Actuator pressure cylinder moves:

- Outward (0 to 1): Valve opens.
- Inward (1 to 0): Valve closes.

Normally Open Valve

Actuator pressure cylinder moves:

- Outward (0 to 1): Valve closes.
- Inward (1 to 0): Valve opens.

Three-Way Valve

Actuator pressure cylinder moves:

- Outward: Valve opens between port NC and C.
- Inward: Valve opens between ports NO and C.

NOTE: The valve body assembly determines the complete assembly action.

Manual Operation

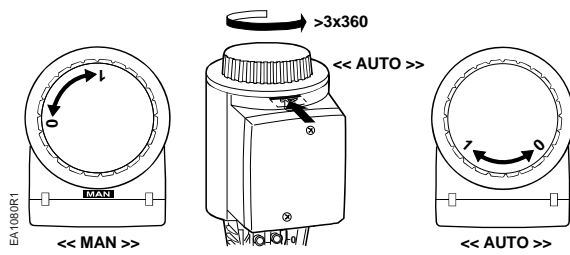

Figure 14. Manual Override in Manual and Automatic Position.

Each complete revolution (360°) is equal to 3/32-inch (2.5 mm) stroke.

Reference

Technical Instruction	Document Number
Flowrite EA599 Series SKD Electronic Valve Actuator Proportional Control	155-180P25
Flowrite EA599 Series SKD Electronic Valve Actuator 3-position(Floating) Control	155-181P25

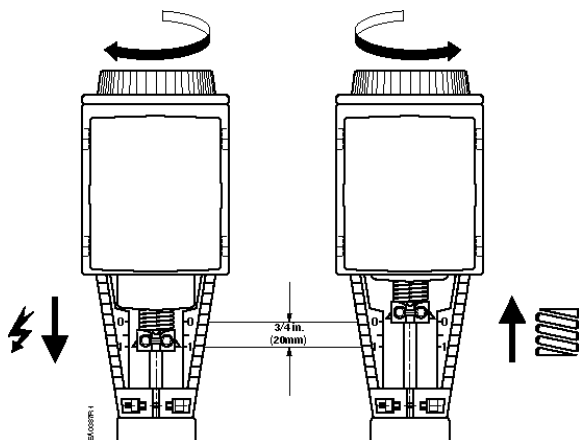

Figure 15. Valve Stem Travel Indication.

Dimensions

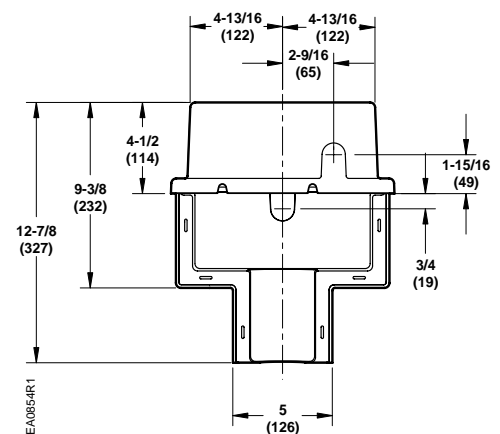
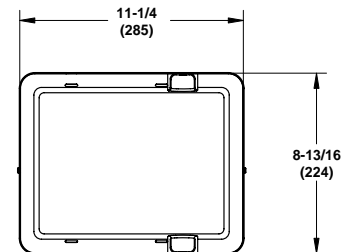

Figure 16. Dimensions of the 599-10071 Weather Shield in inches (mm).

Dimensions, Continued



CAUTION:
 Be careful when removing the knockout. Do not damage the circuit board.

NOTE: Use the top knockout position when installing the Weather Shield.

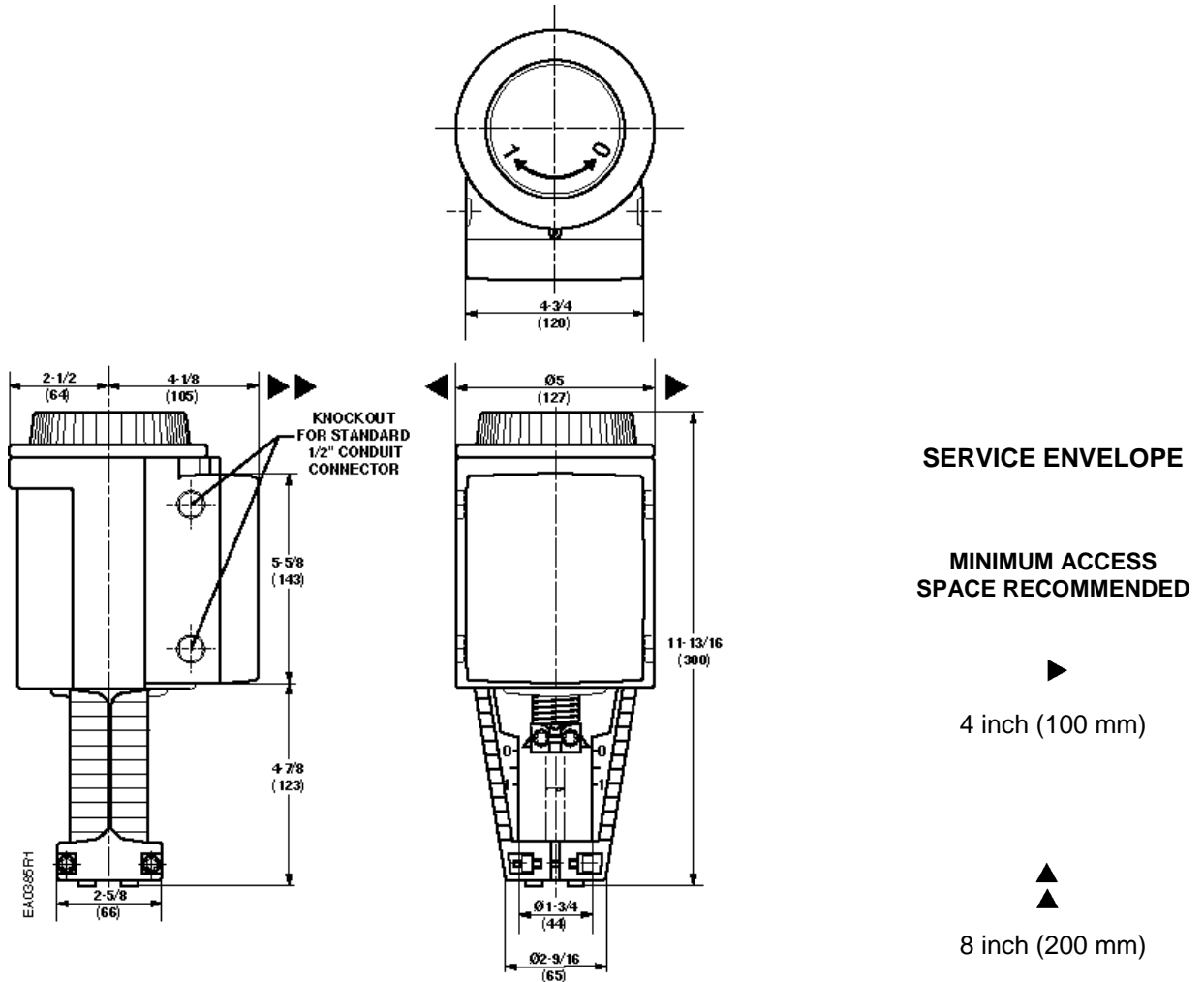

Figure 17. SKD...U Dimensions in Inches (mm).

Information in this publication is based on current specifications. The company reserves the right to make changes in specifications and models as design improvements are introduced. Flowrite is a trademark of Siemens Industry, Inc. Other product or company names mentioned herein may be the trademarks of their respective owners. © 2013 Siemens Industry, Inc.