



# LEVEL & LEAK DETECTION

## POINT LEAK DETECTION SENSOR LIQUI-TECT® 410

### DESCRIPTION

The **Liqui-tect® 410 (LT410)** provides a single-point detection of leaks. The point detection sensor has two gold-plated sensing probes to prevent corrosion resistance and to provide accurate readings. The **LT410** constantly monitors points for leaks, internal faults and power failures and warns of any abnormal conditions. Mounting brackets allow for sensor height adjustments and leveling.

**NEW!**



### APPLICATION

- Glycol, chilled water cooling
- Humification feed water piping
- Condensate pumps and drains
- Unit and ceiling auxiliary drip pans
- Overhead piping troughs



LT410

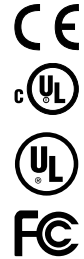

10

LEVEL & LEAK DETECTION

### DIMENSIONS

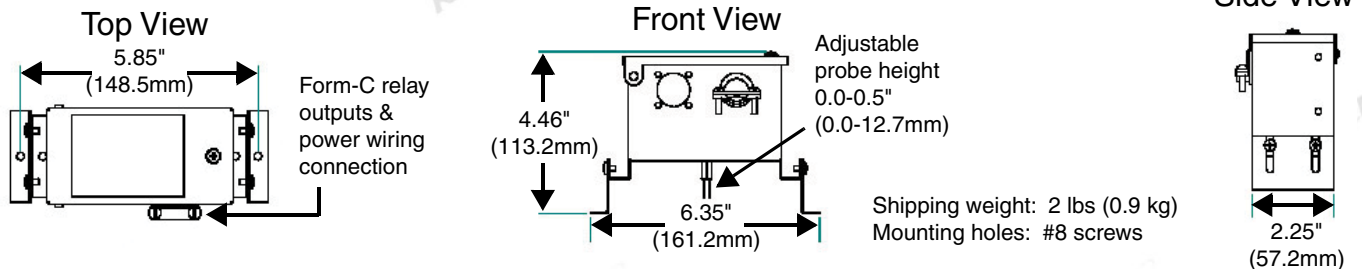

### SPECIFICATIONS

<b>Contact Rating</b>	2 Form-C; 3 A rating at 24 VAC	<b>Power Requirements</b>	24 VAC 100 mA, 50/60 Hz, 3 VA (max.)
<b>Operating Altitude</b>	0 to 10,000 ft (0 to 3,048 m)	<b>Approvals</b>	UL File #E167733, C-UL, CE, FCC Compliance
<b>Operating Humidity</b>	10% to 95% relative humidity (non-condensing)	<b>Weight</b>	2.0 lbs (0.9kg)
<b>Operating Temperature</b>	50°F to 104°F (10°C to 40°C)		
<b>Enclosure Rating</b>	NEMA 1, IP 30		
<b>Dimensions</b>	6.35"W x 2.25"D x 4.46"H (161.2 x 57.2 x 113.2 mm)		

**NEW!**

# LEVEL & LEAK DETECTION

## POINT LEAK DETECTION SENSOR LIQUI-TECT® 410



### WIRING

#### Power Wiring

The LT410 is rated for 24 VAC, 50/60 Hz and 0.10 amp.

Figure 1 24V from Liebert environmental units to LT410

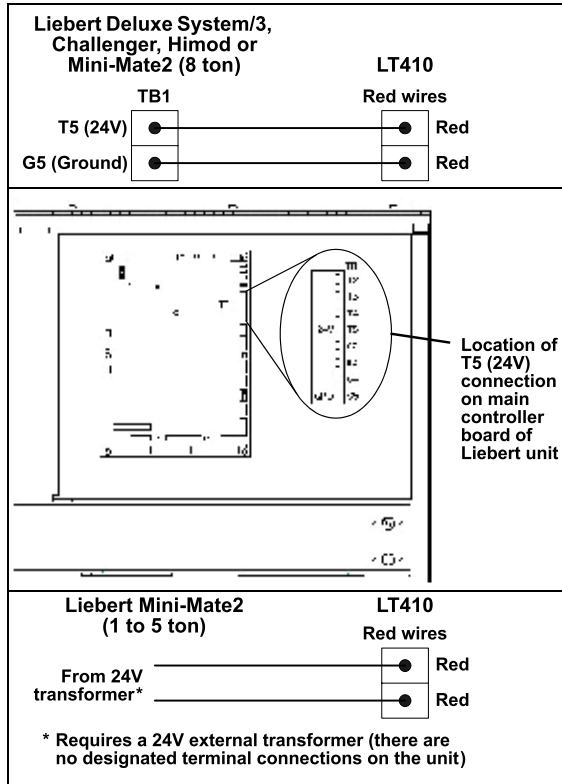
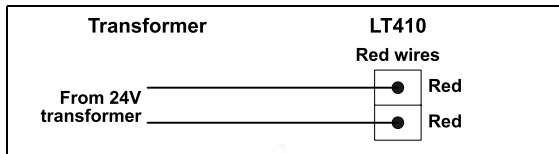

Figure 2 24V from transformer to LT410



#### Wiring to Auxiliary Alarm Panels

The LT410 has two Form-C dry contact alarm output contacts: orange wires (1) and yellow wires (2). Each contact is rated for 24 VAC at 3 amp.

Figure 3 LT410 to Liebert environmental units

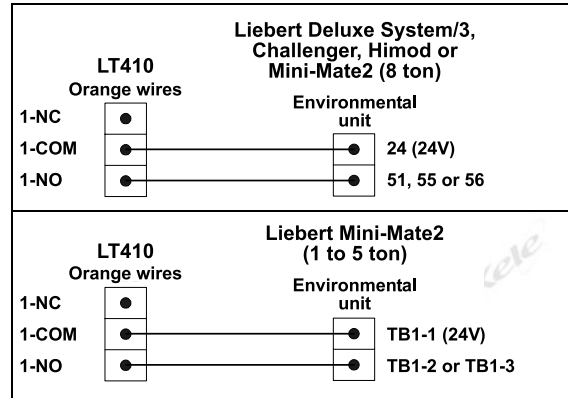
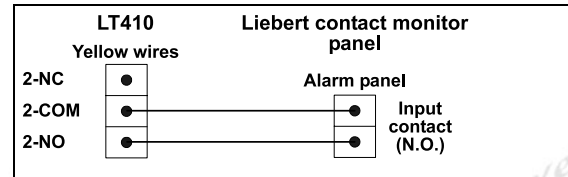
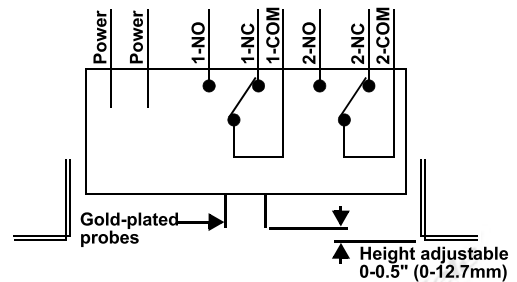

Figure 4 LT410 to Liebert contact monitor panel



#### Wiring Interconnections

Red Wires	Orange Wires	Yellow Wires
24 V, AC/DC @0.10A, 50-60Hz, DC Class 2 Circuit Only	Alarm Contact Rating 24 VAC @ 3A Class 2 Circuit Only	Alarm Contact Rating 24 VAC @ 3A Class 2 Circuit Only



### ORDERING INFORMATION

MODEL	DESCRIPTION
LT410	Point Leak Detection Sensor