



Air Flow Switches

Series AF1

- For general purpose applications with medium and high velocity requirements

Series AF2

- For low velocity applications

Series AF3

- For general purpose low velocity applications where the most economical flow switch is desired

Series AFE-1

- For industrial hazardous environment applications requiring a **NEMA 7 (Class 1, Division 1, Group C and D) or NEMA 9 (Class II, Division I, Group E, F, and G)** rate flow switch for medium velocity.

Application

Air flow switches provide an economical way to detect change or loss of air flow velocity caused by a closed damper or fan inlet, a loose fan wheel, a slipped or broken fanbelt, a dirty or clogged filter, or an overload on a fan motor switch.

Electrical Ratings

Voltage	Motor Switch Rating (Amperes)		Pilot Duty
	Full Load	Locked Rotor	
120 VAC	7.2	44.4	125 VA at 120 or 240 VAC 50 or 60 cycles
240 VAC	3.6	22.2	

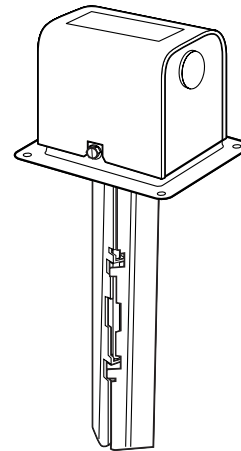

Series AF1

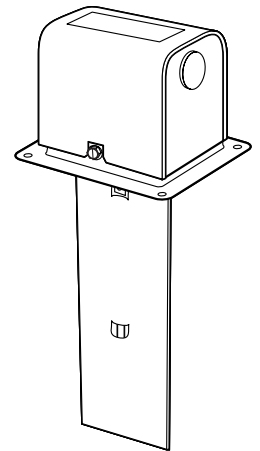

Series AF2

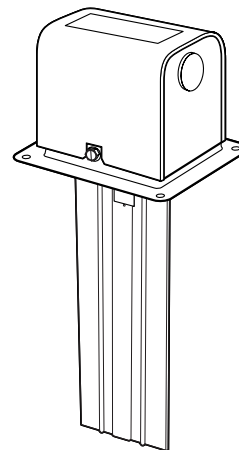

Series AF3

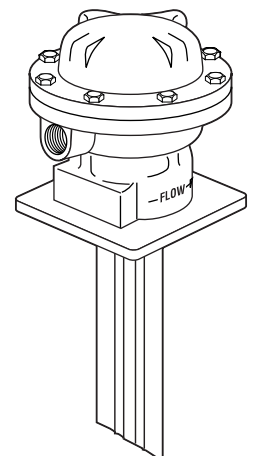

Series AFE-1

WARNING



- Before using this product read and understand instructions.
- Save these instructions for future reference.
- All work must be performed by qualified personnel trained in the proper application, installation, and maintenance of plumbing, steam and electrical equipment and/or systems in accordance with all applicable codes and ordinances.
- To prevent electrical shock, turn off the electrical power before making electrical connections.
- To prevent electrical fire or equipment damage, electrical wiring insulation must have a rating of 167°F (75°C) if the liquid's temperature exceeds 180°F (82°C).
- To prevent electrocution, when the electrical power is connected to the flow switch, do not touch the terminals.
- Make sure flow switch electrical cover is secured before turning on electric power.
- California Proposition 65 warning! This product contains chemicals known to the state of California to cause cancer and birth defects or other reproductive harm.
- Previous controls should never be installed on a new system. Always install new controls on a new boiler or system.

Failure to follow this warning could cause property damage, personal injury or death.

CAUTION:

- A more frequent replacement interval may be necessary based on the condition of the unit at time of inspection. McDonnell & Miller's warranty is one (1) year from date of installation or two (2) years from the date of manufacture.



INSTALLATION

IMPORTANT

The switch should be located about 10 duct diameters downstream from a fan, or 7 diameters downstream from an elbow or any other cause of turbulence.

RECOMMENDED INSTALLATION POSITIONS

The Model AF1, AF1-S, AF2, AF3, and AF3-D Air Flow Switch may be installed in any position. Interior dimensions of the duct must be sufficient to accommodate the paddle. Standard paddle fits into 8" minimum duct size; 2" may be trimmed from end of paddle to fit into ducts as small as 6".

Maximum Ambient Temperature – 120°F (50°C)

The tables below show the velocity of air flow required to actuate McDonnell & Miller AF1, AF1-S, AF2, AF3 and AF3-D air flow switches, in feet per minute (FPM).

AIR FLOW VELOCITY IN FPM (Approximate) REQUIRED TO ACTIVATE SWITCHES

Based on standard air 0.075 pounds per cubic foot. Tabulated flow rates are averages and may vary ± 10% for downward flow.

LOCATION

When ever possible, the Air Flow Switch should be installed in a horizontal duct. Avoid downstream locations too close to elbows, dampers, fans, or other areas of excessive turbulence.

Flow rates required to actuate the Air Flow Switch at minimum and maximum adjustments are shown below. All switches are shipped from the factory set at minimum adjustment.

MAXIMUM DUCT TEMPERATURE

Model No.	Max. Duct Temperature
AF1, AF1-S	300° (149° C)
AF2	300°F (149° C)
AF3, AF3-D, AFE-1	275°F (135° C)

FLOW means that the switch will close circuits C-N.O. and open circuits C-N.C. when flow rate is increased to the FPM shown.

NO FLOW means that the switch will open circuits C-N.O. and close circuits C-N.C. when flow rate is decreased to the FPM shown.

HORIZONTAL DUCT (PREFERRED INSTALLATION)					VERTICAL DUCT — UPWARD FLOW				
Model No.	Air Flow (FPM)				Maximum Air Flow	Air Flow (FPM)			
	Min. (Factory) Adjustment		Maximum Adjustment			Min. (Factory) Adjustment		Maximum Adjustment	
	Flow	No Flow	Flow	No Flow		Flow	No Flow	Flow	No Flow
AF-1, AF1-S	480 (700)*	185 (220)*	1385 (2230)*	1160 (1820)*	910 (1235)*	785 (1050)*	1610 (2560)*	1460 (2410)*	2500
AF-2	380	210	1250	1000	N.A.	N.A.	N.A.	N.A.	2000
AF-3	235	175	1445	1365	N.A.	N.A.	N.A.	N.A.	1200
AF3-D	295	220	1445	1000	560	540	1470	1030	1200

*Standard paddle trimmed to 5 1/4" long.

AFE-1

The versatile AFE-1 meets the need of many applications where the detection of flow or loss of Air Flow must be accomplished in hazardous atmospheres under less-than-ideal conditions.

The AFE-1 responds to medium air flow velocities and switch sensitivity may be readily adjusted to specific rates of flow.

 **CAUTION**

To prevent ignition of hazardous atmosphere, break circuit before removing cover of control, and keep cover tightly closed when in operation.

Designed for industrial applications where a hazardous environment atmosphere is present, the AFE-1 Air Flow Switch is hazardous duty listed by Underwriters for use in Class 1 Group C & D, and Class 2 Group E, F & G atmospheres.

HORIZONTAL DUCTS

	INSTALLED IN HORIZONTAL DUCT	TOP MOUNT (PREFERRED)	SIDE MOUNT
	Factory or Minimum Adjustment	FLOW NO FLOW	350 FPM 100 FPM
Maximum Adjustment	FLOW	1900 FPM	1900 FPM
	NO FLOW	500 FPM	900 FPM

**INSTALL ONLY IN HORIZONTAL DUCTS
DO NOT MOUNT IN VERTICAL DUCT!**

Flow rates are averages which may vary ± 10% from tabulated values. Minimum Duct Size—8" high or 8" wide depending on switch installation.

MECHANICAL INSTALLATION

HORIZONTAL DUCT—Side Mounting

1. Using level, draw 12" line along duct in direction of air flow. Be sure line is true horizontal. (See Diagram A).
2. Mark the four mounting holes and paddle opening.
3. Drill holes and cut out paddle opening.
4. Mount control with air flow direction in duct corresponding to arrows on control. Use gasket and four screws packed with switch.

HORIZONTAL DUCT—BOTTOM OR TOP MOUNTING

1. DRAW 6" line across duct at 90° angle to air flow direction.
2. Using level check duct for horizontal. If duct is not true horizontal it will be necessary to place shims between duct and control to make sure control will be mounted true horizontal. (Diagram B shows how to determine shim size).
3. Mark the four holes and 2⁷/₈" circular paddle opening.

4. Drill holes and cut out paddle opening.
5. Mount control with air flow direction in duct corresponding to arrows on control using shims if necessary. Use gasket and four screws packed with switch.

VERTICAL DUCT

Follow "Horizontal Duct—Bottom or Top Mounting" steps.

Diagram B - Place end of level at high point of duct approx. 1⁷/₈" from line drawn in (1). Measure approximately 3¹/₂" from end and estimate size of shim required to mount control on true horizontal.

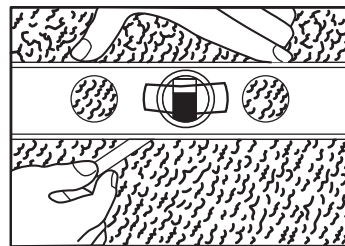

Diagram A

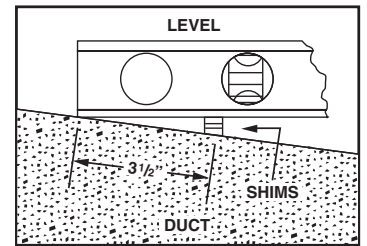
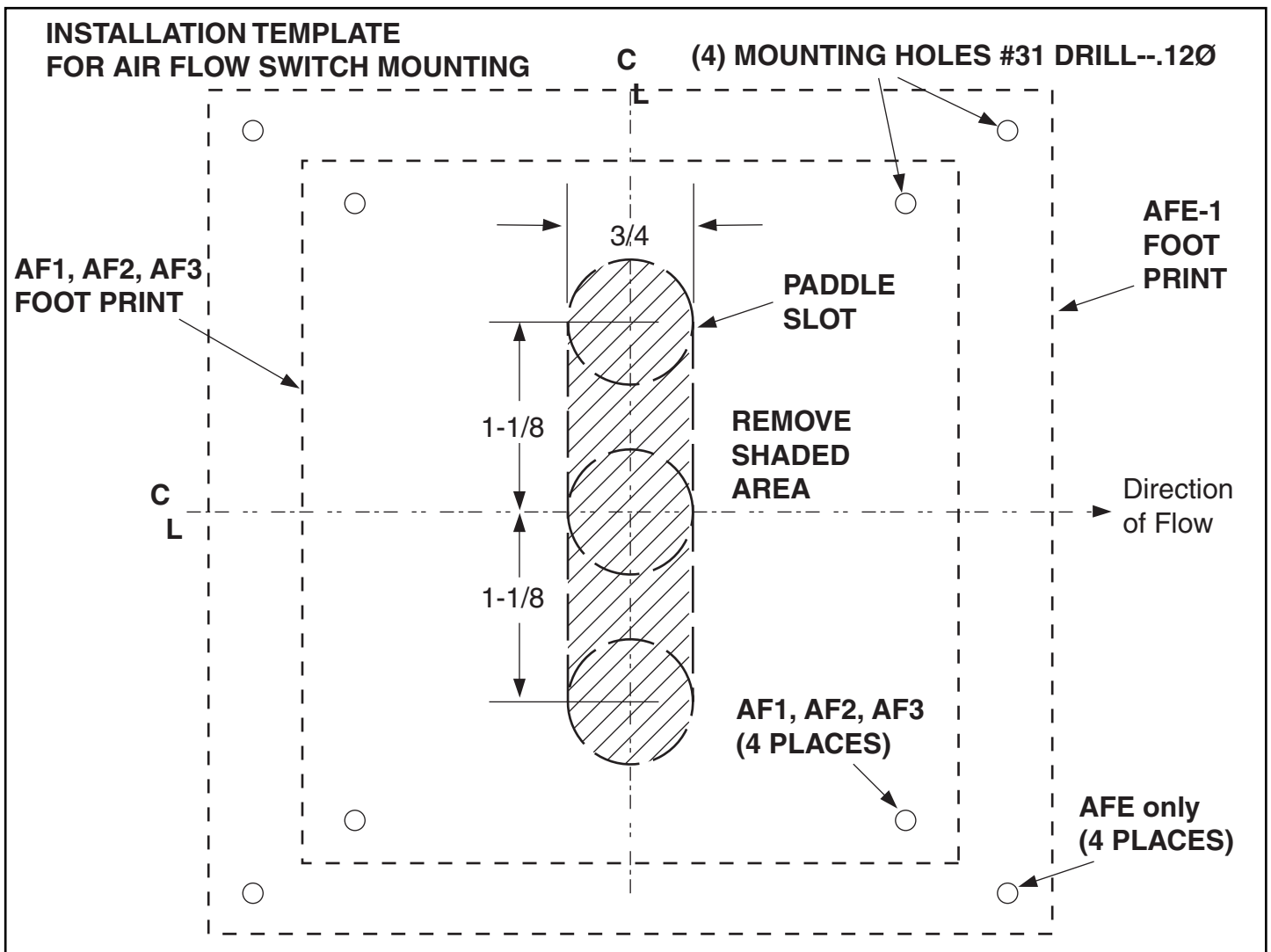

Diagram B



ELECTRICAL INSTALLATION

Switch Operating Schematics

NOTE: DOUBLE SWITCH MODELS CAN PERFORM ANY TWO FUNCTIONS

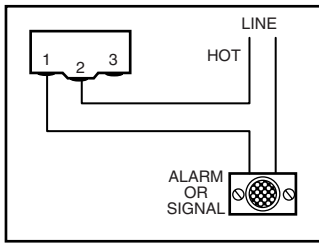

1. Used to sound alarm or light signal when flow occurs.

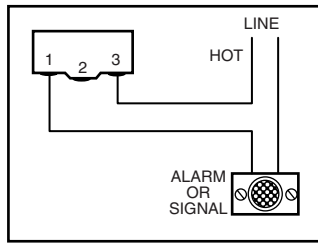

2. Used to sound alarm or light signal when no-flow occurs.

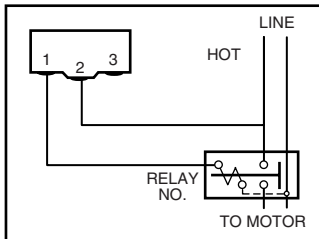

3. Used with single phase circuit-starts motor when flow occurs, stops motor when no-flow occurs.

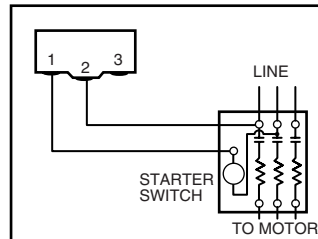

4. Used with three phase circuit-starts motor when flow occurs, stops motor when no-flow occurs.

ON AFE-1

ELECTRICAL

Using approved hazardous duty fittings, conduit, and cable, connect and electrically wire the control in accordance with the wiring instructions.

IMPORTANT

Use wire suitable for at least 90C operation.

MAINTENANCE

SCHEDULE:

- Inspect annually. Turbulent or high flow velocity conditions may require more frequent inspection and/or replacement.
- Replace flow switch every five years or 100,000 cycles, whichever occurs first.

ADJUSTMENT

The adjustment screw is factory set for a minimum flow velocities. To obtain higher velocities before the switch is actuated, turn adjusting screw in clockwise direction.

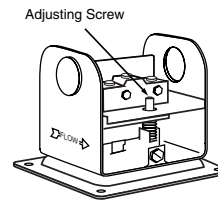

AF3 MODEL

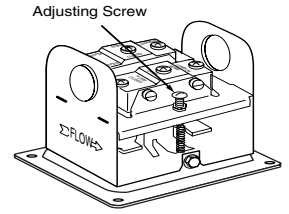

DOUBLE SWITCH MODELS
AF3-D MODEL

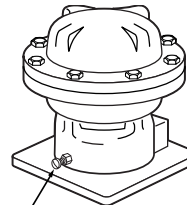

Adjusting Screw & Locknut
(at flange base)

AFE-1 MODEL

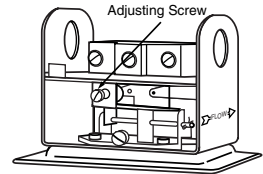

SINGLE SWITCH MODELS
AF1, AF1-S & AF2 MODELS

Troubleshooting

Problem:

1. Flow Switch Does Not Operate

Solution:

- Make sure power has been turned on to device and flow switch.
- Verify that flow rate is high enough for flow switch to activate. Measure flow rate and match with velocities shown in flow rate chart.
- Check to see if paddle moves freely. Some system disassembly may be required.

2. Flow Switch Operates Erratically

Solution:

- Adjustment screw may have been turned below original factory setpoint. Verify that flow rate is high enough for flow switch to activate. Measure flow rate and match with velocities shown in flow rate chart.
- Check to see if paddle moves freely. Some system disassembly may be required.

3. Flow Switch Does Not Deactivate

Solution:

- Check to see if paddle moves freely. Some system disassembly may be required.
- Measure flow rate and match with velocities shown in flow rate chart. Flow switch must prove flow before it can indicate no flow.



Xylem, Inc.
8200 N. Austin Avenue
Morton Grove, Illinois 60053
Phone: (847) 966-3700
Fax: (847) 965-8379
www.xylem.com/brands/mcdonnellmiller

McDonnell & Miller is a trademark of Xylem Inc. or one of its subsidiaries.
© 2013 Xylem Inc. MM-605D July 2013 Part No. 246707