

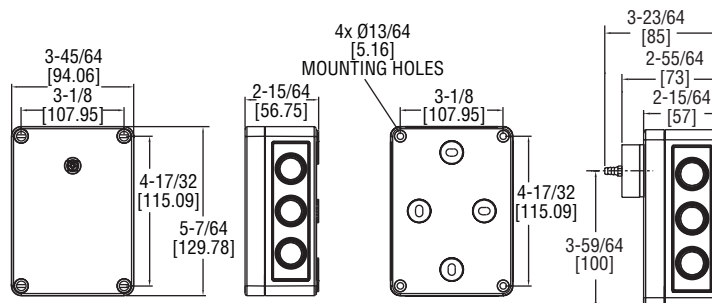

Series GSTA Carbon Monoxide/Nitrogen Dioxide Gas Transmitters

Specifications - Installation and Operating Instructions



The Series GSTA Carbon Monoxide/Nitrogen Dioxide Transmitters monitor the gas concentration in underground parking garages and loading docks. Carbon monoxide is commonly used to measure the exhaust of gasoline engines, while nitrogen dioxide is used for diesel engines. Field selectable current and voltage outputs allow the transmitter to be used with almost any building management controller. For carbon monoxide units, the user can adjust the output range to be 0 to 50 ppm up to 0 to 599 ppm. Nitrogen dioxide units come with a standard 0 to 10 ppm range. The output can be inverted to read 20 to 4 mA or 10 (5) to 0 VDC using internal dip switches.

To maximize the accuracy of the Series GSTA, the sensor can be field-calibrated using the A-449 remote LCD display. When the sensor reaches the end of its life, the display will indicate that the sensor needs to be replaced.

WARNING Disconnect power supply before installation to prevent electrical shock and equipment damage. Make sure all connections are in accordance with the job wiring diagram and in accordance with national and local electrical codes. Use copper conductors only.

CAUTION Use electrostatic discharge precautions (e.g., use of wrist straps) during installation and wiring to prevent equipment damage.

CAUTION Avoid locations where severe shock or vibration, excessive moisture or corrosive fumes are present.

CAUTION Do not exceed ratings of this device, permanent damage not covered by warranty may result. The 4 to 20 mA models are not designed for AC voltage operation.

INSTALLATION

NOTICE These are general guidelines. Local laws or ordinances will take precedence.

- The transmitter should be mounted at normal breathing height, approximately 5 to 6 ft above the floor.
- The unit may be mounted in the horizontal or vertical position. It should be mounted in an area that is shielded from direct contact with the elements or direct sunlight.
- Mount in an area that will prevent the sensor from having any direct contact with water.
- The unit should be placed in an area that will give an average of the air quality. Do not place the unit so it will receive direct engine exhaust. Prolonged exposure to direct engine exhaust may damage the sensor.

MOUNTING

1. Remove the cover plugs from the face of the unit and the top cover.
2. Remove the desired conduit fitting knock out and install conduit fitting (not provided).
3. Position the transmitter where it is to be mounted and mark the mounting holes in each corner of the housing.
4. Drill or punch out marked locations.
5. Place the transmitter box over mounting holes on wall and align. Install wall mount screws (not provided) in mounting holes.
6. Proceed with wiring according to Figures 1 and 2.
7. Set DIP SWITCH and IOUT/VOUT SWITCH as desired. Refer to Figure 3.
8. Replace cover and cover plugs on the face of the unit.

SPECIFICATIONS

Sensor: Field replaceable electrochemical, 4 years typical lifespan.

Range:
CO: 200 ppm or 50 to 599 ppm user adjustable;
NO₂: 10 ppm.

Output Drift: <5% per year in air.

Coverage Area: 5000 to 7500 sq ft typical.

Accuracy: CO: 2%, NO₂: 3% at the time of calibration.

Resolution:
CO: 1 ppm;
NO₂: 0.1 ppm.

Temperature Limits: -4 to 122°F (-20 to 50°C).

Storage Temperature: For best sensor life, 32 to 68°F (0 to 20°C).

Humidity Limits: 15 to 90% RH constant; 0 to 99% RH intermittent.

Response Time: <45 seconds to 90% CO, <25 to 90% NO₂.

Span and Zero Adjustment: Via pushbutton, using optional A-449 display.

Housing: UV resistant glass filled polycarbonate.

Output:
Switch selectable 4 to 20 mA (loop powered), 0 to 5 V @ 5 mA, or 0 to 10 V @ 5 mA;
Switch selectable 0 to 5 V / 1 to 5 V and 0 to 10 V / 2 to 10 V;
Switch selectable normal or reverse output.

Power Supply:
Current output: 10 to 35 VDC;
Voltage output: 15 to 35 VDC or 15 to 29 VAC.

Electrical Connection: Removable terminal block, knock outs for conduit fitting.

Calibration: Via pushbuttons using A-449 auxiliary display. Span gas concentration is field selectable.

Weight: 1 lb (.45 kg).

Agency Approval: CE.

DUCT MOUNTING

Duct mounting kit includes an air flow pitot tube, air filter with barbed connections, two short pieces of tubing and one long piece of tubing.

1. Mount the pitot tube into the duct observing the flow direction marked on the pitot tube.
2. Attach the two short pieces of tubing to the barbed connections on each side of the air filter.
3. Attach the remaining side of one of the short pieces of tubing to the barbed connection on the transmitter.
4. Attach the remaining side of the other short piece of tubing to the high port on the pitot tube.
5. Attach the long piece of tubing to the open barbed connection on the transmitter.
6. Attach the other end of the long tubing to the low port on the pitot tube.

WIRING

Use maximum 18 AWG wire for wiring terminals. Refer to Figure 1 or Figure 2 for wiring information. The terminal block is removable for ease of installation.

Wiring for 4 to 20 mA Output

4 to 20 mA output units may be powered by 10 to 35 VDC.

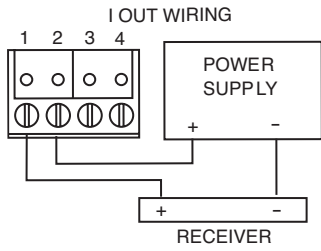

Figure 1

Wiring for 0 to 5 or 0 to 10 V output

The 0 to 5 or 0 to 10 V units may be powered by 15 to 35 VDC or 15 to 29 VAC. Note polarity when using DC power. The maximum load is 5 mA (1 K ohms for 0 to 5 V or 2 K ohms for 0 to 10 V).

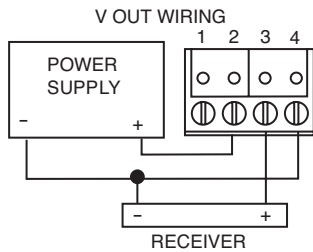

Figure 2

SWITCH LOCATIONS

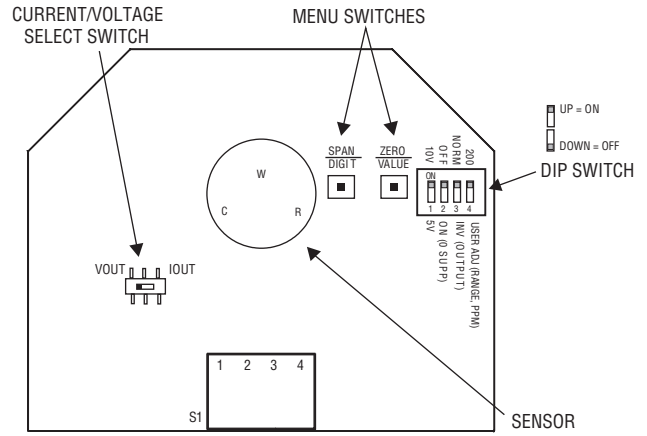

Figure 3

Setting the Current/Voltage Select Switch

To access the current/voltage select switch, remove the cover of the unit. The current/voltage select switch is located on the circuit board as shown in Figure 3. Set the switch to "IOU" for current, "VOUT" for voltage.

DIP SWITCH Settings

To access the DIP SWITCH, remove the cover of the unit. The DIP SWITCH is located on the circuit board as shown in Figure 3.

ALL DIP SWITCHES ARE FACTORY SET TO "ON".

5 V / 10 V Output Select (Applies only to Voltage Output)

DIP SWITCH #1 OFF: Output = 0 to 5 V
 DIP SWITCH #1 ON: Output = 0 to 10 V

Zero Suppression (Applies only to Voltage Output)

DIP SWITCH #2 OFF: Output range = 1 to 5 V or 2 to 10 V, depending on output range
 DIP SWITCH #2 ON: Output range = 0 to 5 V or 0 to 10 V, depending on output range

Output Normal or Invert

DIP SWITCH #3 OFF: Output is inverted
 DIP SWITCH #3 ON: Output is normal

Menu Function (CO Model only)

DIP SWITCH #4 OFF: User ADJ (Output Range)
 DIP SWITCH #4 ON: Sensor calibration/range = 200 ppm

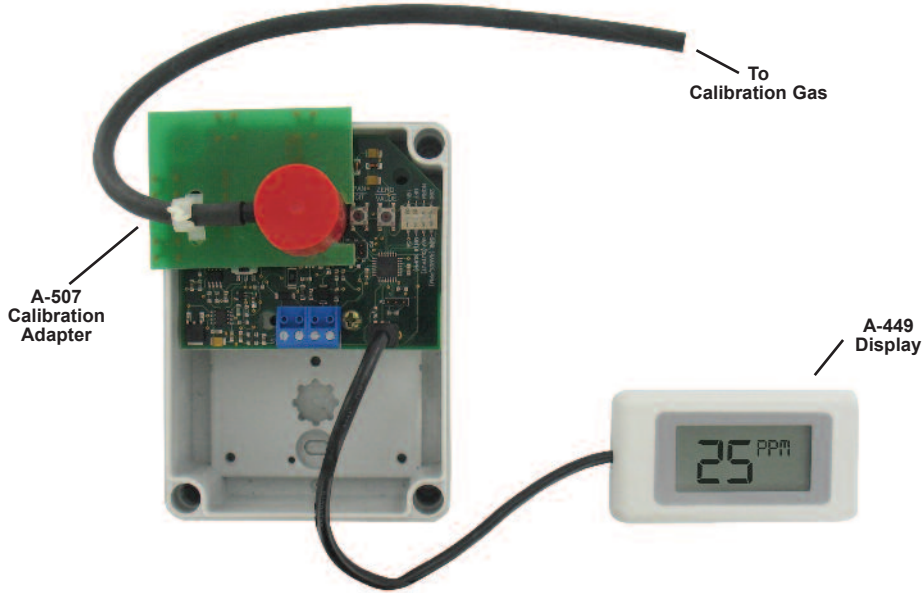

Figure 4

VIEWING THE RANGE

NOTE: Requires auxiliary display A-449. Hook up as shown in Figure 4. Upon power up the unit will momentarily display the range.



or



The range can be displayed at any time by pressing the span key for 5 seconds when in the home position.

The range of the unit is factory set to 200 ppm CO. Also, the range is user adjustable to any value from 50 to 599 ppm CO. If dip switch is set to User ADJ, the factory setting is 100 ppm CO.

SETTING THE USER RANGE

NOTE: Requires auxiliary display A-449. Hook up as shown in Figure 4. Set output range switch to "USER ADJ".

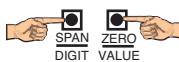

Simultaneously press span and zero buttons for 5 seconds until the upper display reads "ADJ".



Press the digit key to scroll through the digits. The digits will blink as they are selected.



Adjust the value of the digit using the value key.



When the desired range has been selected, press and hold the span key until the lower display reads "ADJ". Then the display will sequence to the home position.



ZERO CALIBRATION

If the unit only requires zero calibration place the unit in an area that contains fresh air (no CO or NO2 gas).



Press and hold the zero key for 5 seconds.

SPAN AND ZERO CALIBRATION

In order to calibrate the span, hook up a model A-449 auxiliary display to the unit as shown in Figure 4. If CO model, set menu function switch to 200 ppm.

In the home position, the display reads actual gas concentration.



Simultaneously press span and zero buttons for 5 seconds. The lower display reads "-0-". The upper display reads "CAL".



Place the unit in an area that contains fresh air (no CO or NO2 gas). Allow 3 minutes to stabilize.



Press the zero key for 5 seconds, the unit will sequence to span calibration and display the user set span calibration gas value. Factory setting is 200 ppm for CO, 10.0 ppm for NO2.



To adjust the display to set the desired span gas calibration value:



Press the digit key to scroll through the digits. The digits will blink as they are selected.



Adjust the value of the digit using the value key.

Hook the unit up to the span calibration gas using calibration adapter A-507 as shown in Figure 4. Span gas flow is to be between 0.5 to 1.0 slpm (1 to 2 scfh). Allow gas to flow for at least 3 minutes.



Press and hold the span key for 5 seconds.

Display reads "CAL OK" for 5 seconds, then returns to home position.



If the sensor output is no longer sufficient for calibration, then the display reads "BAD SEN". The sensor must be replaced.



NOTE: In calibration mode, if no key is pressed, then the unit will time out and return to home position after 10 minutes.

When calibration is complete, set menu function to 200 ppm or USER ADJ as required.

Sensor Replacement

A replacement sensor is available from Dwyer Instruments.
For CO, order part number: A-505
For NO₂, order part number: A-506

 **WARNING** Sensors contain acid. Do not attempt to open sensors. Sensors should be disposed of according to local laws.

Replacing the Sensor

1. Remove the cover plugs from the face of the unit and top cover. Locate the sensor, see Figure 3 – the sensor is mounted on three pin sockets. The circuit board is labeled either “CO SENSOR” or “NO₂ SENSOR” underneath the sensor.
2. Remove and discard the sensor.
3. Remove the shorting wire spring located on the bottom of the new sensor.
4. Install the new sensor into the three pin sockets.
5. The unit must be re-calibrated whenever a new sensor is installed.
6. Allow 30 minutes for the unit to come to temperature equilibrium prior to calibration. The unit has internal temperature compensation, and the sensor must be at the same temperature as the unit to calibrate properly.

TROUBLESHOOTING

1. Verify that the unit is mounted in the correct position.
2. **4 to 20 mA Models:** Verify appropriate supply voltage. The transmitter requires a minimum of 10 and a maximum of 35 VDC at its connection for proper operation. Choose a power supply with a voltage and current rating that meets this requirement under all operating conditions. If the power supply is unregulated, make sure voltage remains within these limits under all power line conditions. Ripple on the supply should not exceed 100 mV.

Loop Resistance – The maximum allowable loop resistance depends on the power supply voltage. Maximum loop voltage drop must not reduce the transmitter voltage below the 10 VDC minimum. Maximum loop resistance can be calculated with the following equation. V_{ps} is the power supply voltage.

$$R_{max} = \frac{V_{ps} - 10.0}{20 \text{ mA}}$$

Some receivers, particularly loop powered indicators, may maintain a fixed loop voltage to power the device. This voltage drop must also be subtracted from the power supply voltage when calculating the voltage margin for the transmitter. The following equation takes this into account. V_{rec} is the receiver fixed voltage.

$$R_{max} = \frac{V_{ps} - 10.0 - V_{rec}}{20 \text{ mA}}$$

0 to 10 V Output Models: Verify appropriate supply voltage. The 0 to 10 V output models require a DC supply of 15 to 35 V or an AC supply of 15 to 29 V for proper operation maximum. Maximum output load is 5 mA.

MAINTENANCE

Upon final installation of the Series GSTA Transmitter and the companion receiver, no routine maintenance is required with the exception of calibration. As with all electrochemical type gas sensors, routine calibration is required. It is recommended the unit be re-calibrated at 6 month intervals or as required by local ordinances or other requirements.

Except for sensor replacement and calibration, the Series GSTA is not field serviceable and should be returned if repair is needed (field repair should not be attempted and may void warranty). Be sure to include a brief description of the problem plus any relevant application notes. Contact customer service to receive a return goods authorization number before shipping.